

DG..2

IME

Via Travaglia 7
20094 CORSICO (MI) ITALIA
Tel. +39 02 44 878.1



www.imeitaly.com

05/18

LE11073AA_01

Glossario

Glossary

Glossaire

Wörterverzeichnis

AL.1 • 2	Allarme 1 • 2	Alarm 1 • 2	Alarme 1 • 2	Alarm 1 • 2
tP.1 • 2	Tipo allarme 1 • 2	Type of alarm 1 • 2	Type de l'alarme 1 • 2	Alarmtyp 1 • 2
Hi	Allarme di massima	High point alarm	Alarme maximum	max. Alarm
Lo	Allarme di minima	Low point alarm	Alarme minimum	min. Alarm
St.1 • 2	Soglia 1 • 2	Threshold 1 • 2	Seuil 1 • 2	Schwelle 1 • 2
rL.1 • 2	Stato relè 1 • 2	State of relay 1 • 2	Etat du relais 1 • 2	Relaiszustand 1 • 2
n.d	Normalmente disecitato	Normally de-energized	Normalement désexcité	Normalerweise abgefallen
n.E	Normalmente eccitato	Normally energized	Normalement excité	Normalerweise angezogen
HS.1 • 2	Isteresi allarme 1 • 2	Hysteresis alarm 1 • 2	Hystérésis alarme 1 • 2	Hysteresse Alarm 1 • 2
dL.1 • 2	Ritardo intervento 1 • 2	Operating delay 1 • 2	Temporisation 1 • 2	Einsatzverzögerung 1 • 2

4 moduli module DIN43880

72 x 72mm DIN43700

96 x 48mm DIN43700

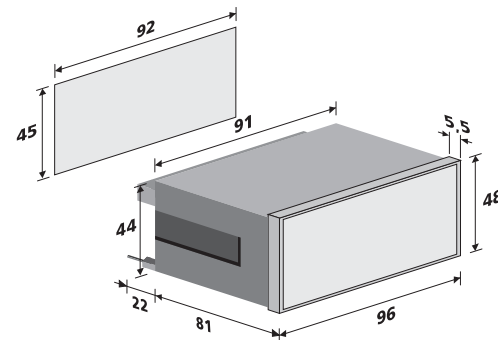
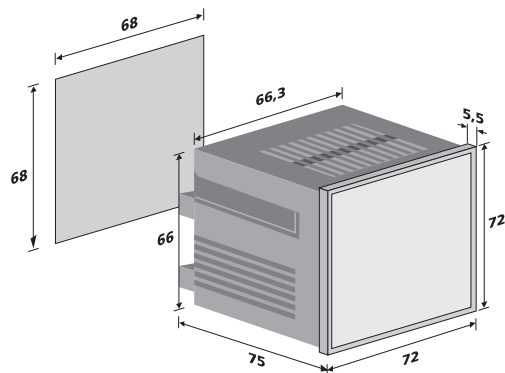
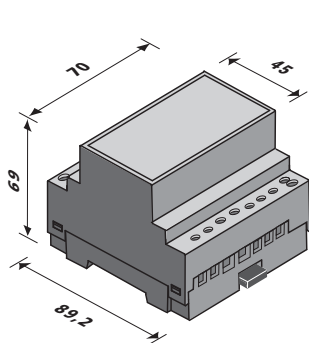

DG4G2

S 305/134

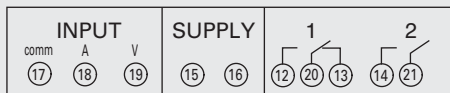

DGMG2

S 305/136

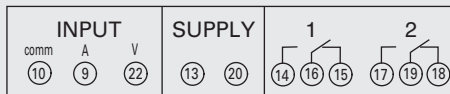

DG7G2

S 305/140

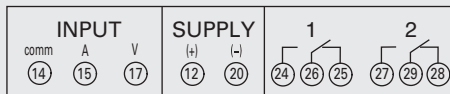

DG4D2

S 305/142

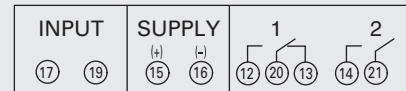

DGMD2 • DGMS2

S 305/145

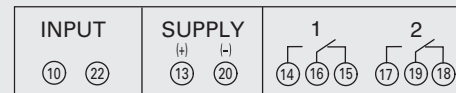

DGMM2

S 305/148

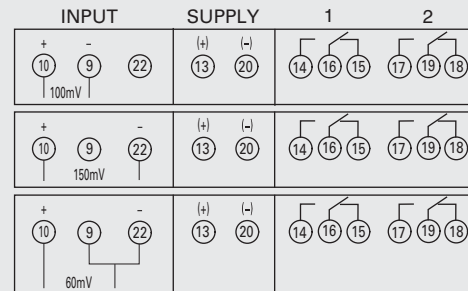

DGMN2

S 305/149

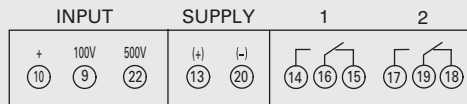

DG7M2

S 305/152

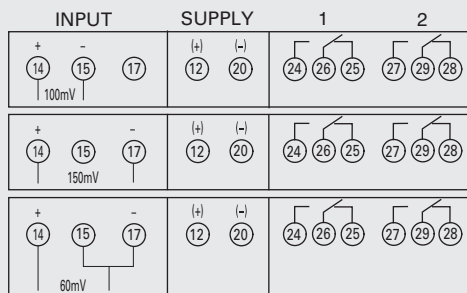

DG7N2

S 305/153

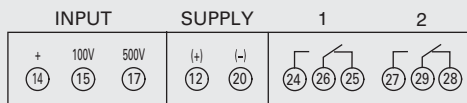

DG4M2

S 305/156

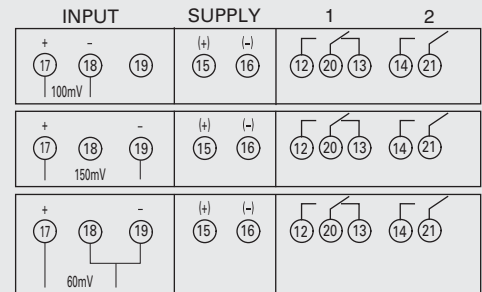

DG4N2

S 305/157

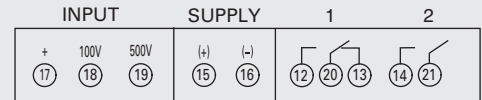

DGMA2

S 305/159



DG7A2

S 305/162

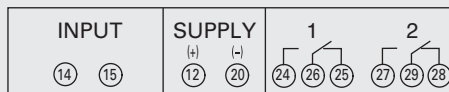

DG7D2

S 305/163

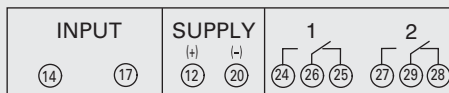

DG4A2

S 305/173

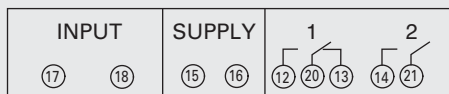

Der Programmiermodus kann jederzeit verlassen werden, indem Sie **PG** solange gedrückt halten bis am Display **End** erscheint.
Nach einigen Sekunden kehrt das Gerät in den Anzeigemodus zurück, ohne Speicherung der schon eingegebenen Parameter. ■

Indice

Istruzioni per l'installazione 2

Parametri programmabili 3

Visualizzazione 4

Programmazione 5

Istruzioni per l'installazione

La posizione di fissaggio (grado di inclinazione) risulta completamente indifferente ai fini del funzionamento.

Prima di procedere all'installazione, accertarsi che i dati di targa corrispondano a quelli richiesti (tipo di ingresso, valore di alimentazione ausiliaria, ecc.)

Nei cablaggi rispettare scrupolosamente lo schema di inserzione, una inesattezza nei collegamenti è inevitabile causa di misure falsate o di danni allo strumento.





Nei collegamenti evitare di disporre i cavi parallelamente a conduttori di potenza o in prossimità di sorgenti di campi elettromagnetici intensi (es. grossi trasformatori, teleruttori, ecc.)

La tensione di alimentazione ausiliaria deve essere possibilmente indipendente dalla misura e sempre presente, per garantire continuità di sorveglianza. ■





• ALARME

- 4 Am Display erscheint **AL.1**
- 5 Drücken Sie **PG**; am Display erscheint **tp.1** (Alarmtyp) gefolgt von **Hi** (max. Alarm).
- 6 Drücken Sie **PG** um die Auswahl zu bestätigen oder **SET** um die Auswahl auf **Lo** (MIN-Alarm) abzuändern.
Drücken die dann **PG** um die Auswahl zu bestätigen.
- 7 Am Display erscheint **rl.1** (Relaiszustand) gefolgt von **n.d** (normalerweise abgefallen). Drücken Sie **PG** um die Auswahl zu bestätigen oder **SET** um die Auswahl auf **n.E.** (normalerweise angezogen) abzuändern.
Drücken die dann **PG** um die Auswahl zu bestätigen.
- 8 Am Display erscheint **St.1** (Grenzwert) gefolgt von dem zuletzt eingegebenen Grenzwert.
- 9 Durch mehrmaliges Drücken von **SET** kann der Wert verändert werden.
Wenn der gewünschte Wert angezeigt wird, drücken Sie **PG**.
- 10 Am Display erscheint **HS.1** (Hysterese) gefolgt vom Wert des vorher eingegebenen Grenzwertes.
- 11 Drücken Sie **PG** um die Auswahl (keine Hysterese) zu bestätigen oder drücken Sie solange **SET** bis der gewünschte Wert angezeigt wird.
Bestätigen Sie dann mit **PG**.
- 12 Am Display erscheint **dL.1** (Ansprechverzögerung) gefolgt von 000.
- 13 Drücken Sie **PG** um die Auswahl (keine Verzögerung) zu bestätigen oder drücken Sie solange **SET** bis der gewünschte Wert angezeigt wird.
Bestätigen Sie dann mit **PG**.
- 14 Am Display erscheint **AL.2**
- 15 Drücken Sie **PG**. Wiederholen Sie die oben beschriebene Punkte 5...13, um den Alarm 2 zu programmieren.
- 16 Wenn die Programmierung abgeschlossen ist, erscheint am Display **End**.
Drücken die **SET** um die programmierten Parameter zu bestätigen.
- 17 Am Display erscheint **Sto** (Bestätigung der Speicherung).
Das Gerät kehrt in den Anzeigemodus zurück.





DG.A2 • Eingang 10A Wechselstrom

- 1  Drücken **PG** um das Programmierungsmenu einzutreten
- 2  Drücken **SET** bis den gewünschten Bereich dargestellt wird **10**
- 3  Drücken **PG**
Sehen **ALARMPROGRAMMIERUNG (4 )**

DG.A2 • Eingang 20A Wechselstrom

- 1  Drücken **PG** um das Programmierungsmenu einzutreten
- 2  Drücken **SET** bis den gewünschten Bereich dargestellt wird **20**
- 3  Drücken **PG**
Sehen **ALARMPROGRAMMIERUNG (4 )**

DG.G2 • Eingang 500V Wechselspannung - TA/5 oder /1A Wechselstrom

- 1  Drücken **PG**; am Display erscheint - **U** -
- 2  **a** Wenn Sie das Gerät zur Wechselspannungsmessung verwenden wollen, drücken Sie noch einmal **PG (weiter mit Punkt 4 )**
- b** Wenn Sie das Gerät zur Wechselspannungsmessung verwenden wollen, drücken Sie **SET**; am Display erscheint - **A** -
- 3  Drücken **PG**
Sehen **ALARMPROGRAMMIERUNG (4 )**

DG.S2 • Eingang 10...100Hz (100...500V)

Diese Ausführung benötigt keine Bereichsprogrammiierung; deswegen gehen Sie direkt zur **ALARMPROGRAMMIERUNG (4 )**.

Parametri programmabili**• ALLARMI**

Lo strumento è dotato di 2 allarmi completamente indipendenti e programmabili. Per ogni singolo allarme è possibile selezionare:

- Tipo allarme (tP.)

massima (Hi)
minima (Lo)

- Soglia (St.)**- Stato relè (rL.)**

normalmente diseccitato (n.d.)
normalmente eccitato (n.E)

- Isteresi (HS.)**- Ritardo intervento (dL.)**

1...60s. ■



Visualizzazione

• ALLARMI



Al superamento di una o di entrambe le soglie predisposte, lo strumento visualizza alternativamente il valore istantaneo misurato e la dicitura **AL**. Al rientro dalla condizione di allarme, la dicitura **AL** scompare e lo strumento visualizza unicamente il valore istantaneo. ■

Programmierung

• EINGANG





DG.M2 • Eingang 60 - 100 - 150mV Gleichstrom

Die Wahl des Eingangswerts wird durch den Klemmenbrettanschluss getroffen





- 1  Drücken **PG** um das Programmierungsmenu einzutreten
- 2  Drücken **SET** bis den gewünschten Bereich dargestellt wird
- 3  Drücken **PG**
Sehen **ALARMPROGRAMMIERUNG** (4 )

DG.N2 • Eingang 100 - 500V Gleichspannung

Die Wahl des Eingangswerts wird durch den Klemmenbrettanschluss getroffen

- 1  Drücken **PG** um das Programmierungsmenu einzutreten
- 2  Drücken **SET** bis den gewünschten Bereich dargestellt wird
- 3  Drücken **PG**
Sehen **ALARMPROGRAMMIERUNG** (4 )

DG.D2 • Eingang 100V Wechselspannung

- 1  Drücken **PG** um das Programmierungsmenu einzutreten
- 2  Drücken **SET** bis den gewünschten Bereich dargestellt wird
- 3  Drücken **PG**
Sehen **ALARMPROGRAMMIERUNG** (4 )

Anzeige

• ALARME

Bei der Überschreitung einer oder beider eingestellten Grenzwerte, zeigt das Gerät wechselweise den gemessenen Momentanwert und die Aufschrift **AL.** an.





Nach Beendigung des Alarmzustands erlischt die Aufschrift **AL.** und das Gerät zeigt nur noch den gemessenen Momentanwert an. ■

Programmazione

• INGRESSO





DG.M2 • Ingresso 60 - 100 - 150mV cc

La selezione del valore di ingresso viene effettuata tramite il collegamento in morsettiera





- 1  Premere **PG** per entrare nel menù di programmazione
- 2  Premere **SET** fino a visualizzare la portata desiderata
- 3  Premere **PG**
Vedi **Programmazione ALLARMI** (4 )

DG.N2 • Ingresso 100 - 500V cc

La selezione del valore di ingresso viene effettuata tramite il collegamento in morsettiera

- 1  Premere **PG** per entrare nel menù di programmazione
- 2  Premere **SET** fino a visualizzare la portata desiderata
- 3  Premere **PG**
Vedi **Programmazione ALLARMI** (4 )

DG.D2 • Ingresso 100V ca

- 1  Premere **PG** per entrare nel menù di programmazione
- 2  Premere **SET** fino a visualizzare la portata desiderata
- 3  Premere **PG**
Vedi **Programmazione ALLARMI** (4 )

DG.A2 • Ingresso 10A ca

- 1 Premere **PG** per entrare nel menù di programmazione
- 2 Premere **SET** fino a visualizzare la portata **10**
- 3 Premere **PG**
Vedi **Programmazione ALLARMI (4)**

DG.A2 • Ingresso 20A ca

- 1 Premere **PG** per entrare nel menù di programmazione
- 2 Premere **SET** fino a visualizzare la portata **20**
- 3 Premere **PG**
Vedi **Programmazione ALLARMI (4)**

DG.G2 • Ingresso 500V ca - TA/5 opp. /1A ca

- 1 Premere **PG** sul display appare - **U** -
- 2 **a** Se si desidera utilizzare lo strumento per misure di tensione, premere nuovamente **PG (vedi p.to 4)**
 - b** Se si desidera utilizzare lo strumento per misure di corrente, premere **SET**, fino a visualizzare la portata desiderata
- 3 Premere **PG**
Vedi **Programmazione ALLARMI (4)**

DG.S2 • Ingresso 10...100Hz (100...500V)

Questa versione non necessita di programmazione della portata, passare direttamente alla **Programmazione ALLARMI (4)**.

Programmierbare Parameter**• ALARME**

Das Gerät hat zwei völlig voneinander unabhängige und programmierbare Alarme. Für jeden Alarm kann folgendes parametrisiert werden:

- Alarmtyp (tP.)

Max. (Hi)
Min. (Lo)

- Grenzwert (St.)**- Relaiszustand (rL.)**

normalerweise abgefallen (n.d.)
normalerweise angezogen (n.E)

- Hysterese (HS.)**- Ansprechverzögerung (dL.)**

1...60s. ■

Installation

Die Einbaulage (Neigungsgrad) hat keinen Einfluß auf die Funktion.

Bevor diese Geräte eingebaut werden, sollte das Typenschild mit den tatsächlichen Netzgegebenheiten verglichen werden (Eingang, Hilfsspannung usw.)

Der Anschluß erfolgt gem. Anschlußbilder. Falschanschluß führt zu erheblichen Anzeigefehlern! Es können sogar Beschädigungen auftreten. Vermeiden Sie die Verlegung der Anschlußkabel neben stromführenden Leitern oder Geräten mit großen elektromagnetischem Feld (Transformatoren, Fernschalter, usw.).

Die Hilfsspannungsversorgung sollte unabhängig vom Meßkreis sein. Um eine stetige Überwachung zu gewährleisten, muß die Hilfsspannung ständig eingeschaltet bleiben. ■

• ALLARMI

- 4 Sul display appare **AL.1**
- 5 Premere **PG** sul display appare **tp.1** (tipo allarme) seguito da **Hi** (allarme di massima)
- 6 Se si desidera impostare un allarme di massima, confermare la selezione premendo **PG** e passare al punto successivo altrimenti premere **SET**.
Sul display appare **Lo** (allarme di minima).
Confermare la selezione premendo **PG**.
- 7 Sul display appare **rL.1** (stato relè) seguito da **n.d** (normalmente diseccitato)
Premere **PG** per confermare la selezione oppure **SET** per modificarla in **n.E** (normalmente eccitato) quindi premere **PG**.
- 8 Sul display appare **St.1** (soglia) seguito dall'ultimo valore impostato
- 9 Premere ripetutamente **SET** fino a visualizzare il valore desiderato, quindi premere **PG**.
- 10 Sul display appare **HS.1** (isteresi) seguito dal valore impostato come soglia.
- 11 Se si desidera un'isteresi nulla (punto di ripristino uguale al punto di intervento) premere **PG**, altrimenti premere **SET** fino a visualizzare il valore desiderato. Quindi premere **PG**.
- 12 Sul display appare **dL.1** (ritardo intervento) seguito da 000.
- 13 Se si desidera un intervento istantaneo premere **PG** altrimenti premere più volte **SET** fino a visualizzare il ritardo desiderato (da 1 a 60 secondi) quindi premere **PG**.
- 14 Sul display appare **AL.2**
- 15 Premere **PG** e ripetere le operazioni descritte per l'allarme 1 (punti 5...13) fino ad ultimare la programmazione dell'allarme 2.
- 16 Terminata la programmazione sul display appare **End**.
Per confermare i parametri programmati premere **SET**.
- 17 Sul display appare **Sto** che conferma l'avvenuta memorizzazione e lo strumento si riporta in fase di visualizzazione misura.

In qualsiasi momento è possibile uscire dalla fase di programmazione, premendo e tenendo premuto **PG** fino a quando il display visualizza **End**. Dopo qualche istante, lo strumento si riporta in fase di visualizzazione misura, senza memorizzare alcun cambiamento di programmazione. ■

Index

Installation 2

Programmierbare Parameter 3

Anzeige 4

Programmierung 5

17  l'indicateur affiche **Sto** qui confirme la mémorisation; puis l'appareil se repositionne en mode affichage de la mesure.

A chaque moment il est possible de quitter la phase de programmation en restant appuyé sur **PG** jusqu'à ce que l'indicateur affiche **End**.
Après quelques instants l'appareil se repositionne en mode affichage de la mesure sans mémoriser aucun changement de programmation. ■

Index

Mounting instructions 2

Programmable parameters 3

Display 4

Programming 5

Mounting instructions

Working is not affected, in any way, by the mounting position (angle of elevation).

Before mounting these meters it is necessary to verify that data on the label correspond to the ones required (type of input, auxiliary supply, etc.)

In the wiring scrupulously respect the wiring diagram; an error in connection unavoidably leads to wrong measurements or damages to the meter.

In the connections, avoid placing the cables in parallel with power conductors or near to strong electromagnetic field sources (for instance big transformers, remote control switches, etc.)





If possible, auxiliary supply voltage must be independent from measuring and must always be present to guarantee a monitoring continuity.

Programmation





• ALARMES

- 4 l'indicateur affiche **AL.1**
- 5 Appuyer sur **PG**; l'indicateur affiche **tP.1** (type de l'alarme) suivi par **Hi** (alarme maximum)
- 6 Si on veut fixer une alarme maximum, valider la sélection en appuyant sur **PG** et passer au point suivant, autrement appuyer sur **SET**.
l'indicateur affiche **Lo** (alarme minimum).
Valider la sélection en appuyant sur **PG**.
- 7 l'indicateur affiche **rL.1** (état du relais) suivi par **n.d** (normalement dés-excité).
Appuyer sur **PG** pour valider la sélection ou sur **SET** pour la modifier en **n.E** (normalement excité) ; puis appuyer sur **PG**.
- 8 l'indicateur affiche **St.1** (seuil) suivi par la dernière valeur mémorisée.
- 9 Appuyer plusieurs fois sur **SET** jusqu'à afficher la valeur désirée, puis appuyer sur **PG**.
- 10 l'indicateur affiche **HS.1** (hystérésis) suivi par la valeur mémorisée comme seuil.
- 11 Si on veut une hystérésis nulle (point de réarmement égal au point de consigne) appuyer sur **PG**, autrement appuyer sur **SET** jusqu'à afficher la valeur désirée. Puis appuyer sur **PG**.
- 12 l'indicateur affiche **dL.1** (retard d'intervention) suivi par 000.
- 13 Si on veut une temporisation instantanée appuyer sur **PG**, autrement appuyer plusieurs fois sur **SET** jusqu'à afficher la valeur désirée (de 1 jusqu'à 60 secondes). Puis appuyer sur **PG**.
- 14 l'indicateur affiche **AL.2**.
- 15 Appuyer sur **PG** et répéter les opérations décrites pour l'alarme 1 (points 5...13) jusqu'à la fin de la programmation de l'alarme 2.
- 16 La programmation terminée, l'indicateur affiche **End**.
Pour valider les paramètres programmés appuyer sur **SET**.





DG.A2 • Entrée 10A ca

- 1  Appuyer **PG** pour entrer dans le menu de programmation
- 2  Appuyer **SET** jusqu'à l'étendue **10** est affichée
- 3  Appuyer **PG**
Voir **Programmation des ALARMES** (4 )

DG.A2 • Entrée 20A ca

- 1  Appuyer **PG** pour entrer dans le menu de programmation
- 2  Appuyer **SET** jusqu'à l'étendue **20** est affichée
- 3  Appuyer **PG**
Voir **Programmation des ALARMES** (4 )

DG.G2 • Entrée 500V ca - TA/5 ou /1A ca

- 1  Appuyer **PG**; l'afficheur montre - **U** -
- 2  **a** Si on veut utiliser l'appareil pour des mesures de tension alternative, appuyer encore une fois sur **PG** (**voir point 4** )
b Si on veut utiliser l'appareil pour des mesures de courant alternatif, appuyer sur **SET**; jusqu'à l'étendue désirée est affichée
- 3  Appuyer **PG**
Voir **Programmation des ALARMES** (4 )

DG.S2 • Entrée 10...100Hz (100...500V)

Cette version ne nécessite pas de la programmation de l'étendue ; donc vous passez directement à la **programmation des ALARMES**.

Programmable parameters**• ALARMS**

The meters are equipped with 2 fully independent and programmable alarms. For each alarm it is possible to select:

- Type of alarm (tP.)

high point (Hi)
low point (Lo)

- Threshold (St.)**- State of relay (rL.)**

normally de-energized (n.d.)
normally energized (n.E)

- Hysteresis (HS.)**- Operating delay (dL.)**

1...60. ■

Display

• ALARMS

By passing one or both of the set thresholds, the meter alternatively displays the measured instantaneous value and the legend **AL.**



When the alarm condition is over, the legend **AL.** disappears and the meter displays only the measured instantaneous value. ■

Programmation

• ENTREE

DG.M2 • Entrée 60 - 100 - 150mV cc



La sélection de la valeur d'entrée est faite par le raccordement en bornier

- 1  Appuyer **PG** pour entrer dans le menu de programmation
- 2  Appuyer **SET** jusqu'à l'étendue désirée est affichée
- 3  Appuyer **PG**

Voir Programmation des ALARMES (4 )



DG.N2 • Entrée 100 - 500V cc

La sélection de la valeur d'entrée est faite par le raccordement en bornier

- 1  Appuyer **PG** pour entrer dans le menu de programmation
- 2  Appuyer **SET** jusqu'à l'étendue désirée est affichée
- 3  Appuyer **PG**

Voir Programmation des ALARMES (4 )

DG.D2 • Entrée 100V ca

- 1  Appuyer **PG** pour entrer dans le menu de programmation
- 2  Appuyer **SET** jusqu'à l'étendue désirée est affichée
- 3  Appuyer **PG**

Voir Programmation des ALARMES (4 )

Affichage

• ALARMES

Au dépassement de un ou des deux seuils fixés, l'appareil affiche alternativement la valeur instantanée mesurée et la légende **AL**





Quand la condition d'alarme est terminée, la légende **AL** disparaît et l'appareil affiche seulement la valeur instantanée mesurée. ■

Programming

• INPUT





DG.M2 • Input 60 - 100 - 150mV dc

Input value selection is made through terminal board connection





- 1  Press **PG** to enter programming menu
- 2  Press **SET** until desired range is displayed
- 3  Press **PG**
See **ALARM programming** (4 )

DG.N2 • Input 100 - 500V dc

Input value selection is made through terminal board connection





- 1  Press **PG** to enter programming menu
- 2  Press **SET** until desired range is displayed
- 3  Press **PG**
See **ALARM programming** (4 )

DG.D2 • Input 100V ac





- 1  Press **PG** to enter programming menu
- 2  Press **SET** until desired range is displayed
- 3  Press **PG**
See **ALARM programming** (4 )







DG.A2 • Input 10A ac

- 1  Press **PG** to enter programming menu
- 2  Press **SET** until **10** range is displayed
- 3  Press **PG**
See **Programming ALARMS** (4 

DG.A2 • Input 20A ac

- 1  Press **PG** to enter programming menu
- 2  Press **SET** until **20** range is displayed
- 3  Press **PG**
See **Programming ALARMS** (4 

DG.G2 • Input 500V ac - TA/5 or /1A ac

- 1  Press **PG** the display shows - **U -**.
- 2  **a** If you want to use the meter for alternating voltage measurements, press once again **PG** (see item 4 
b If you want to use the meter for alternating current measurements, press **SET**; until desired range is displayed
- 3  Press **PG**
See **Programming ALARMS** (4 

DG.S2 • Input 10...100Hz (100...500V)

This version doesn't need any range programming ; therefore you directly go to the **ALARMS programming** (4 

Paramètres programmables**• ALARMES**

L'appareil est pourvu de 2 alarmes complètement indépendantes et programmables. Pour chaque alarme il est possible de sélectionner :

- type de alarme (tP.)

maximum (Hi)
minimum (Lo)

- Seuil (St.)**- Etat des relais (rL .)**

normalement désexcité (n.d.)
normalement excité (n.E)

- Hystérésis (HS.)**- Temporisation (dL.)**

1...60s. ■

Instructions pour l'installation

La position de montage (degré d'inclinaison) n'a aucune incidence sur le fonctionnement.

Avant de procéder à l'installation, vérifier que les données indiquées sur la plaque correspondent à celles demandées (type d'entrée, valeur de l'alimentation auxiliaire, etc.)

Lors du câblage, respecter scrupuleusement le schéma de raccordement, une connexion erronée est source inévitable de fausses mesures ou de dommages à l'appareil.

Lors des connexions, éviter de mettre les câbles parallèlement aux conducteurs de puissance ou à proximité des sources de champs électromagnétiques intenses (ex. grands transformateurs, etc.)

Dans la mesure du possible, l'alimentation auxiliaire doit être indépendante de la mesure et être toujours présente pour garantir la continuité de la surveillance.

Programming

• ALARMS

- 4 Display shows **AL.1**
- 5 Press **PG**; the display shows **tp.1** (type of alarm) followed by **Hi** (high point alarm).
- 6 If you want to set a max. alarm, confirm the selection by pressing **PG** passing then to the next item, otherwise press **SET**.
Display shows **Lo** (low point alarm).
Confirm the selection by pressing **PG**.
- 7 Display shows **rL.1** (state of relay) followed by **n.d** (normally de-energized)
Press **PG** to confirm the selection or **SET** to turn it into **n.E** (normally energized), then press **PG**.
- 8 Display shows **St.1** (threshold) followed by the last loaded value.
- 9 Repeatedly press **SET** until the display shows desired value, then press **PG**.
- 10 Display shows **HS.1** (hysteresis) followed by the value loaded as threshold.
- 11 If you want a null hysteresis (restart point equal to operating point) press **PG**, otherwise press **SET** until the display shows desired value. Then press **PG**.
- 12 Display shows **dL.1** (operating delay) followed by 000.
- 13 If you want an instantaneous intervention press **PG**, otherwise repeatedly press **SET** until the desired delay is displayed (from 1 up to 60 seconds), then press **PG**.
- 14 Display shows **AL.2**
- 15 Press **PG** and repeat the operations described for alarm 1 (items 5...13) until programming of alarm 2 is over.
- 16 When programming is over, display shows **End**. To confirm programmed parameters press **SET**.

17  Display shows **Sto** which confirms storage; the meter returns to measuring display phase.

In any moment you can leave the programming phase just by pressing, and keeping pressed, **PG** until display shows **End**.
After few seconds the meter returns to measuring display without storing any programming change. ■

Sommaire

Instructions pour l'installation 2

Paramètres programmables 3

Affichage 4

Programmation 5