

104 870 199/01

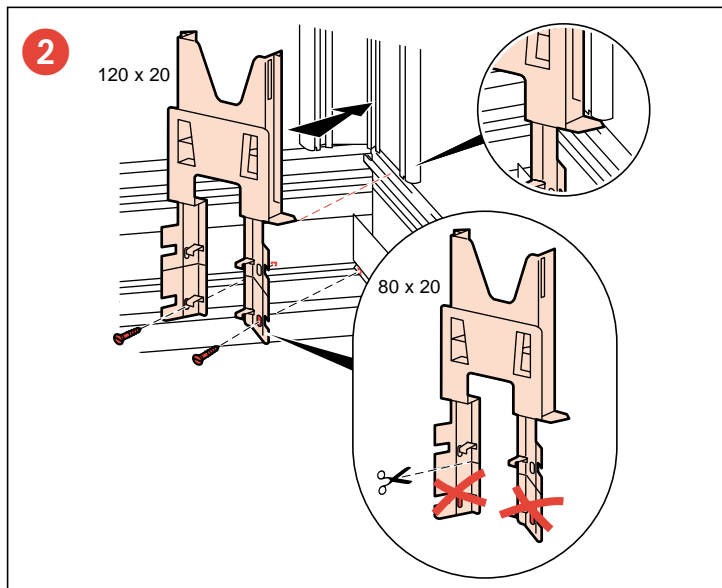

3

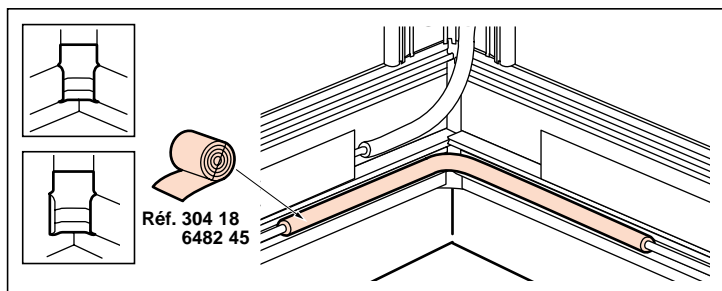
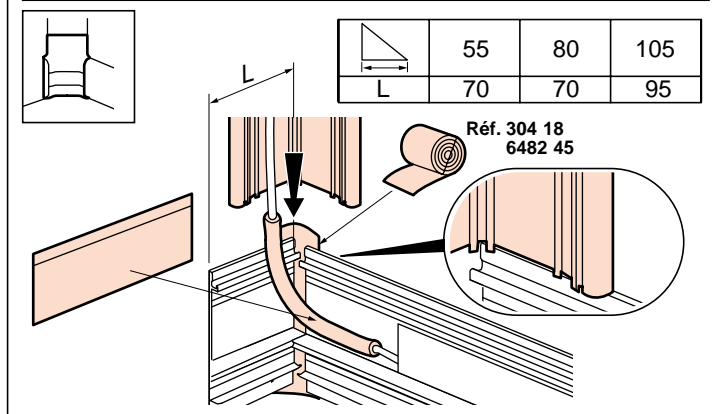
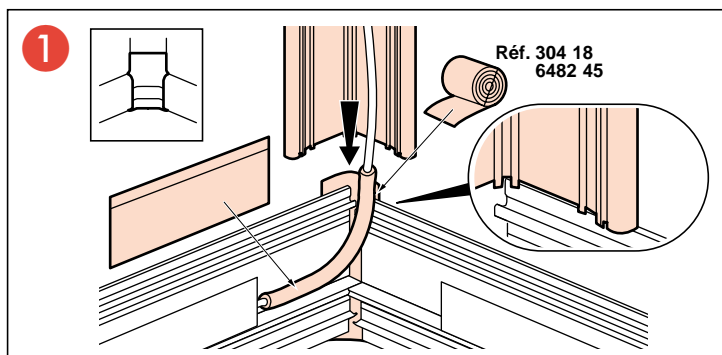
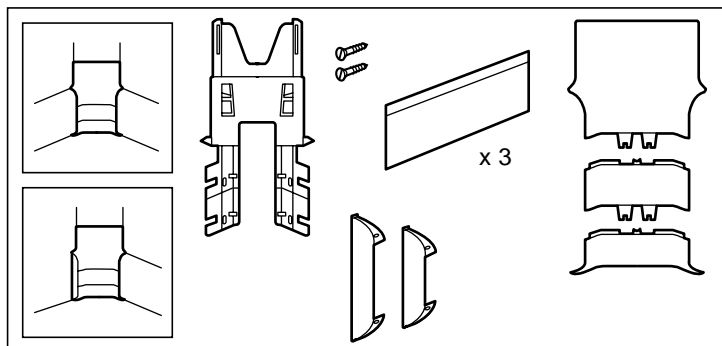
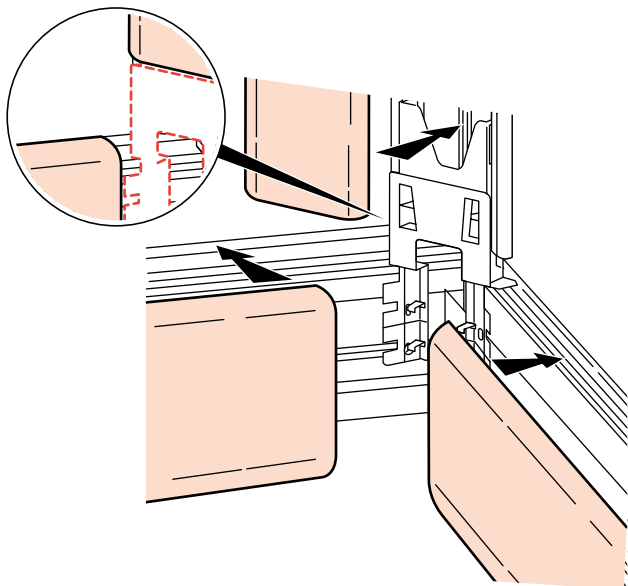

4

