

3

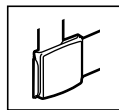
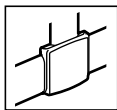
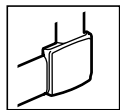
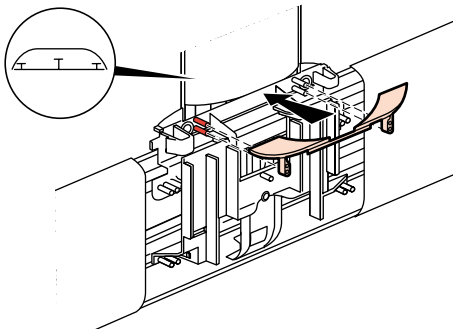

80x20

80x20

80x20

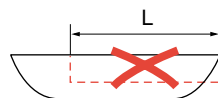
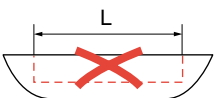
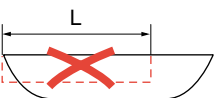
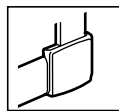
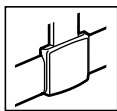
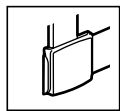
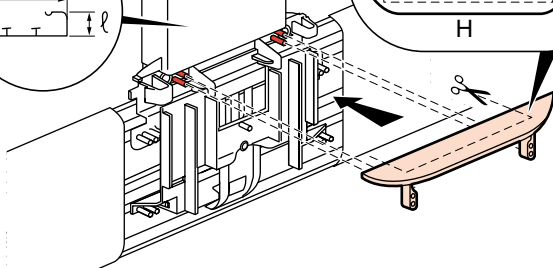
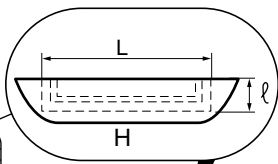
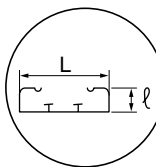
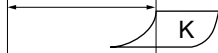
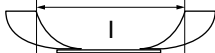
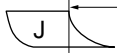

4

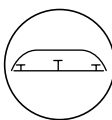

120 x 20

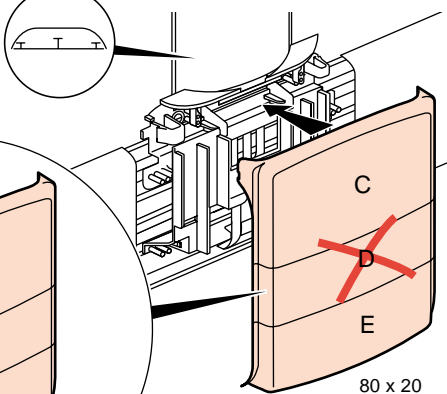
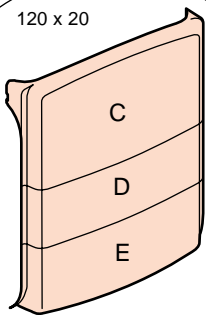

80 x 20

