

500 91



Pro & Consumer Service  
FR 50091 / 1 - 87002 L'Espresso Centre 1 / www.legrandelectric.com  
Service consommateurs  
FR 500 300 10 15 61000 TTC / www.legrand.fr

N° 50091 482 012  
© LEGRAND 2006

**RALLONGE 4 PRISES SAFE CONTROL  
1,5 m - Avec inter**  
**SAFE CONTROL 4-VOUDIGE TAFELCONTACTDOOS  
1,5 m - Met schakelaar**

- Protège contre les surcharges électriques et les risques d'échauffement
- Livré avec collier auto-agrippant
- Beveiligd tegen elektrische overbelastingen en oververhittingsrisico's
- Geleverd met een zelfhechtende kabelband



Cordon  
Snoer



Sécurité enfant  
Kinderveiligheid



Fixable  
Te bevestigen



Special chargeur  
Speciaal voor lader

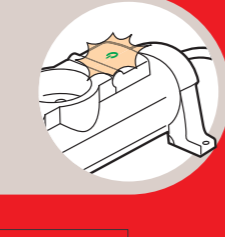

Cordon  
Snoer



Sécurité enfant  
Kinderveiligheid



Fixable  
Te bevestigen



Special chargeur  
Speciaal voor lader

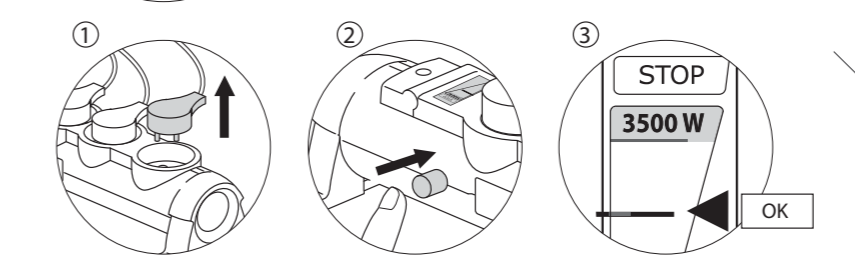
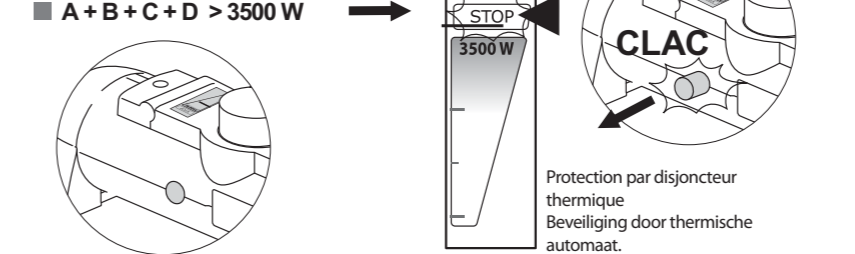
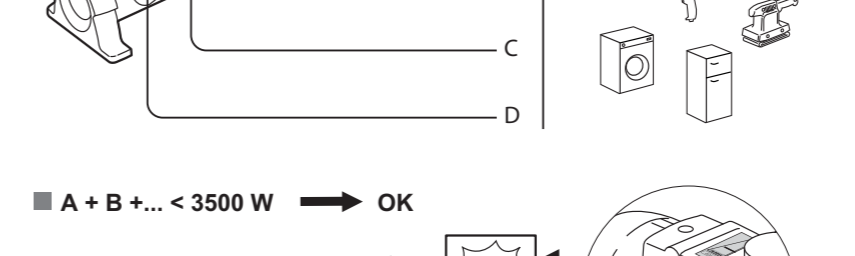
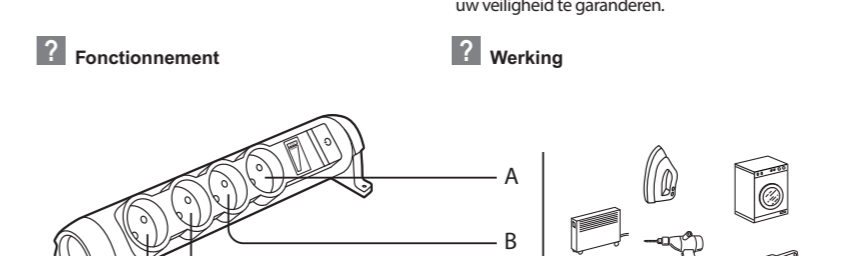
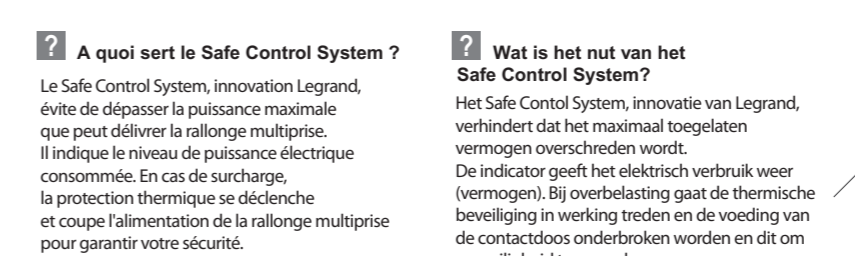
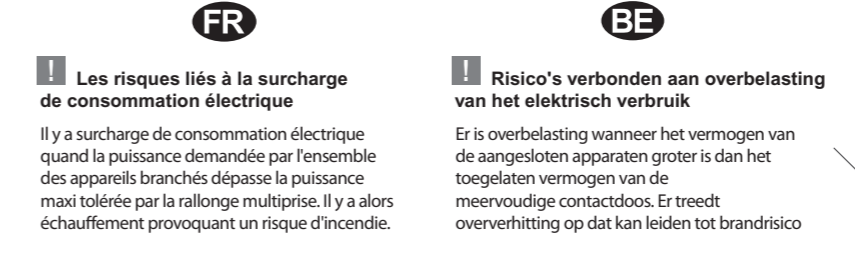
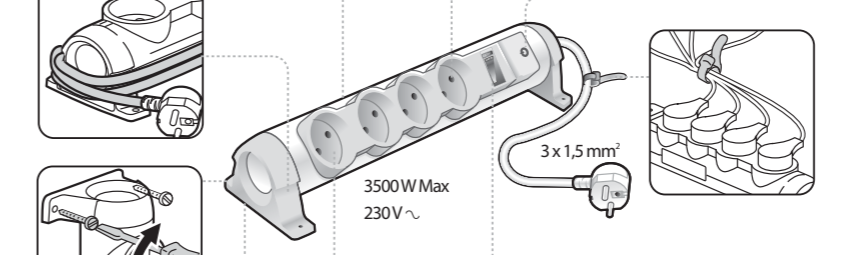
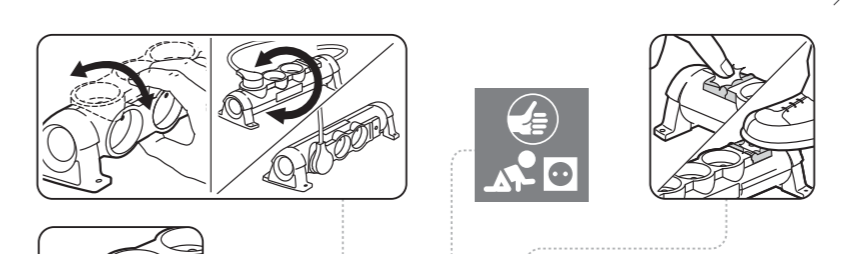
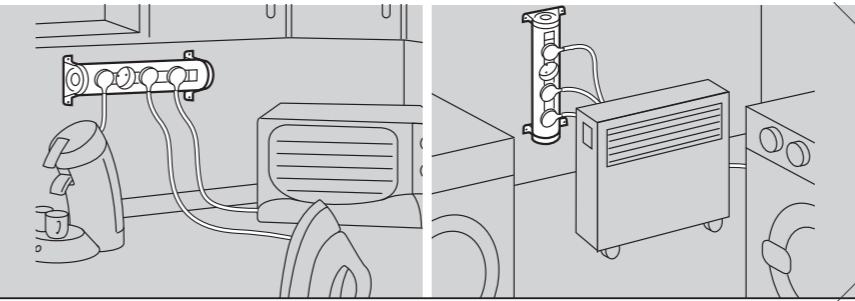
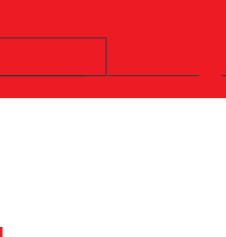
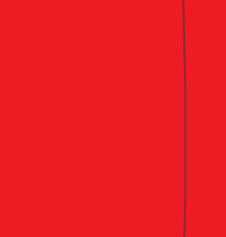
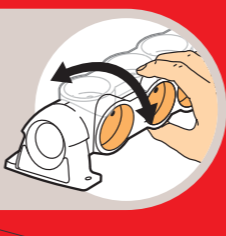

FR

**1 Les risques liés à la surcharge de consommation électrique**  
Il y a surcharge de consommation électrique quand la puissance demandée par l'ensemble des appareils branchés dépasse la puissance max tolérée par la rallonge multiprise. Il y a alors échauffement provoquant un risque d'incendie.

**2 A quoi sert le Safe Control System ?**  
Le Safe Control System, innovation Legrand, évite de dépasser la puissance maximale que peut délivrer la rallonge multiprise. Il indique le niveau de puissance électrique consommée. En cas de surcharge, la protection thermique se déclenche et coupe l'alimentation de la rallonge multiprise pour garantir votre sécurité.

**2 Fonctionnement**

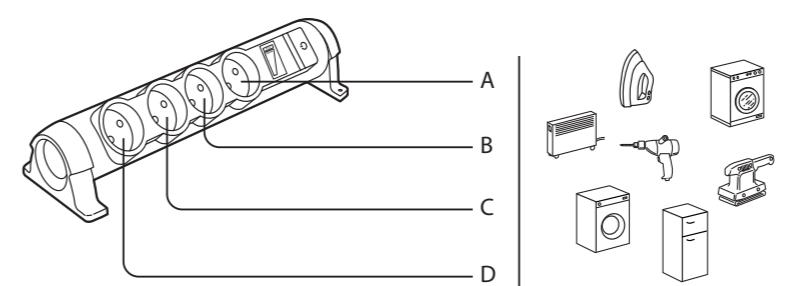

■ A + B + ... < 3500 W → OK

■ A + B + C + D > 3500 W →

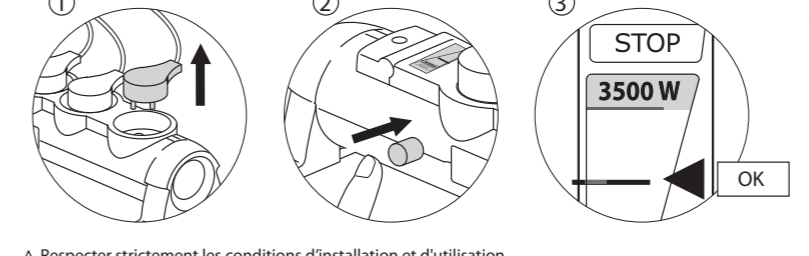
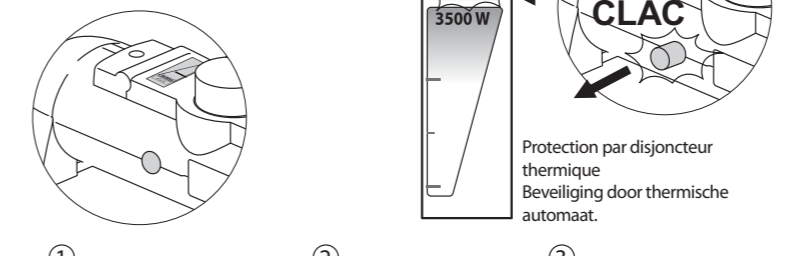

Respecter strictement les conditions d'installation et d'utilisation  
Respecteer strict de installatie- en gebruiksvoorwaarden



3 245060 500917

**legrand** RALLONGE 4 PRISES SAFE CONTROL  
SAFE CONTROL 4-VOUDIGE TAFELCONTACTDOOS

