

<p>7756 69</p>	<p>7756 11</p>				
		<p>12-15 V=</p>	<p>MONO 1 x 1 W STEREO 2 x 1 W</p>	<p>87,5 MHz ↓ 108 MHz</p>	<p>10 max.</p>

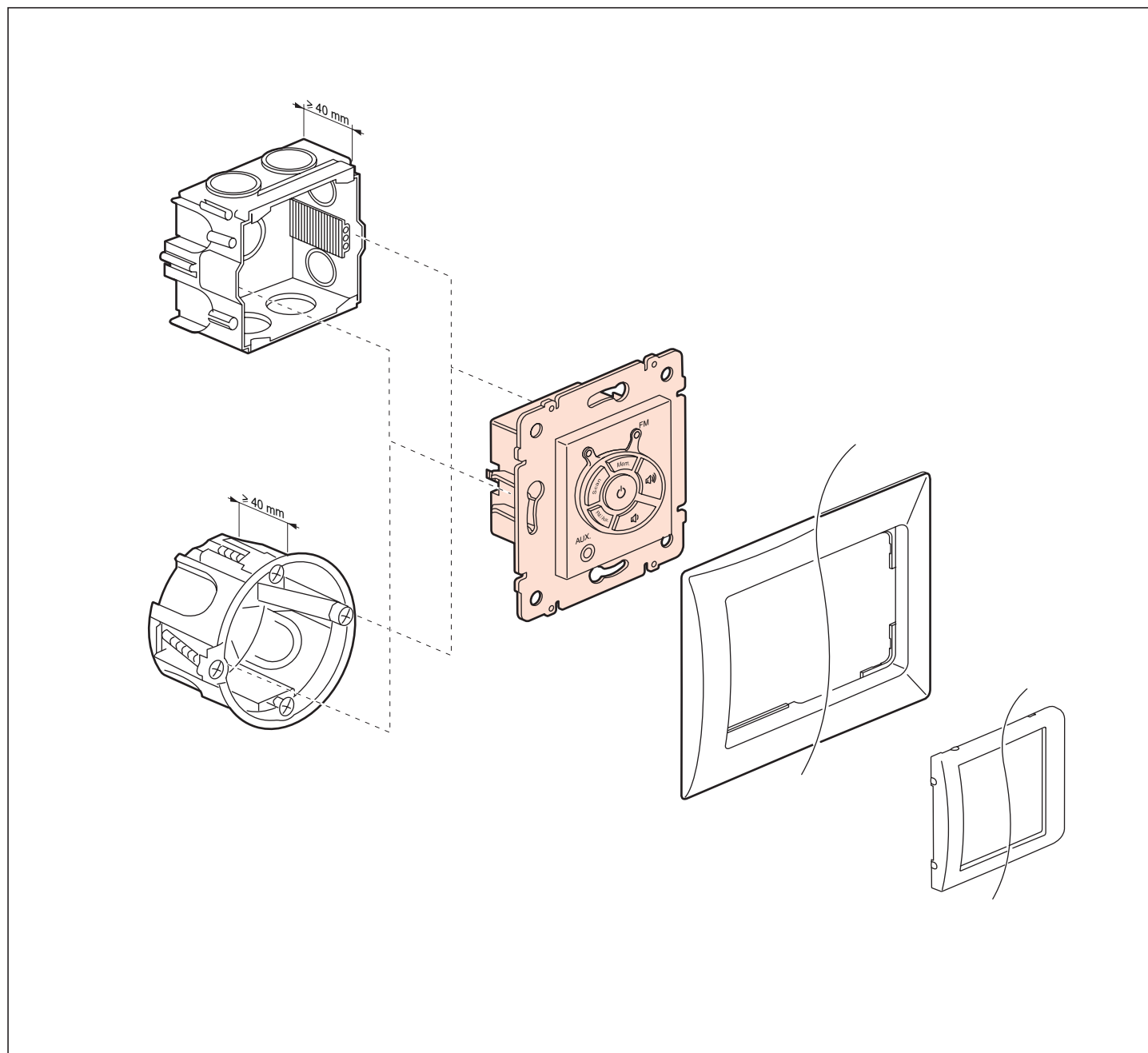

	<p>047 96</p>	<p>673 22</p>	<p>7756 74</p>	
775 669	✓	✓	✓	
775 611	✓	✓		

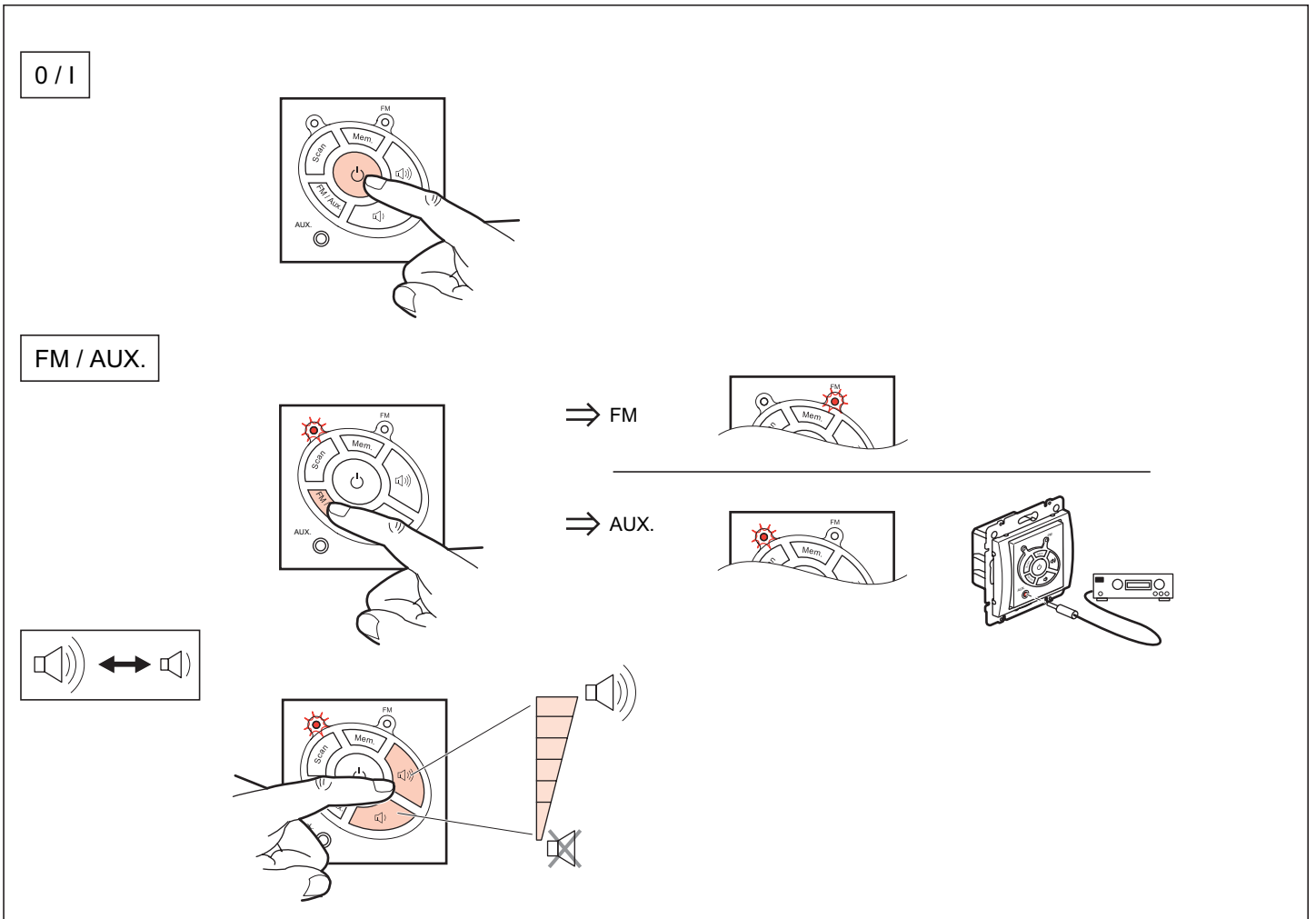
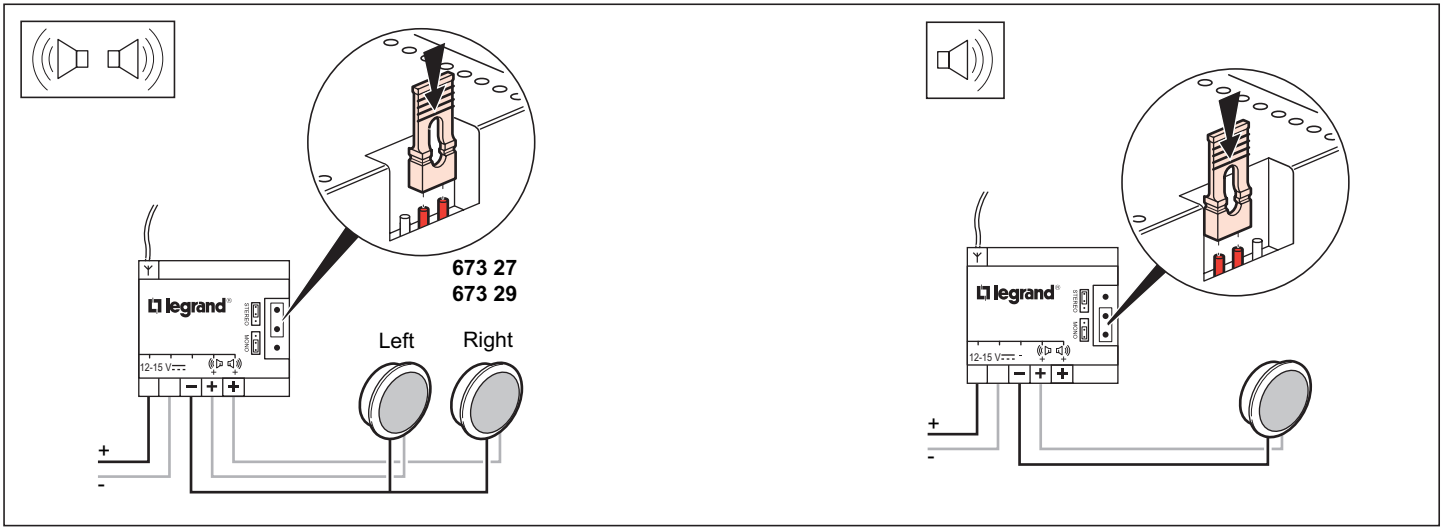

SCAN

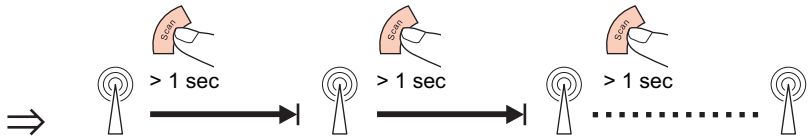
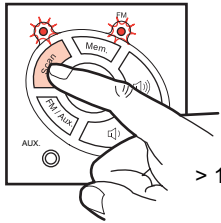
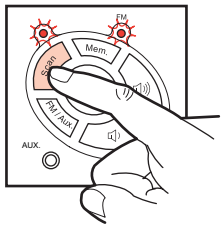

MEM

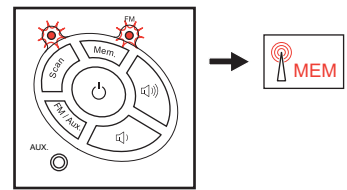
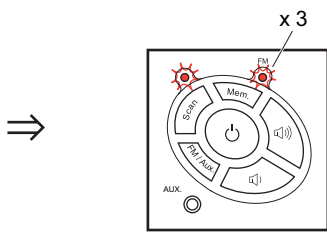
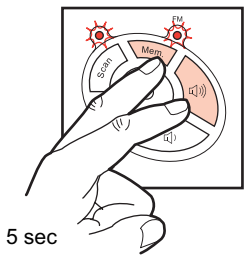

MEM AUTO

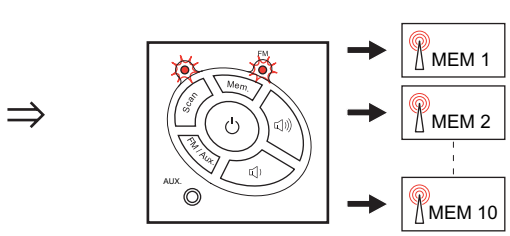
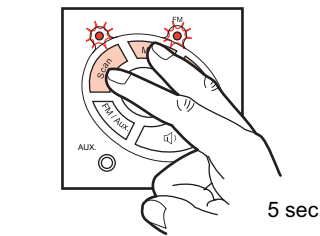

SELECTION MEM



MEM

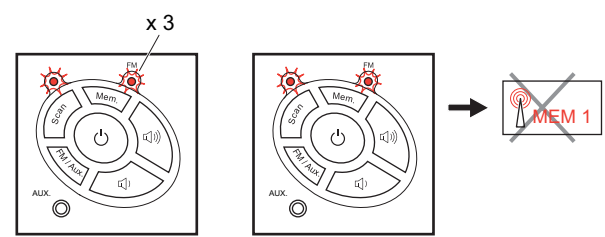
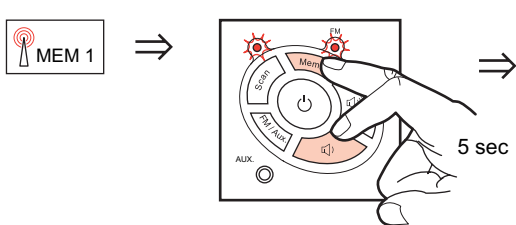

 → SENSITIVITY
FM

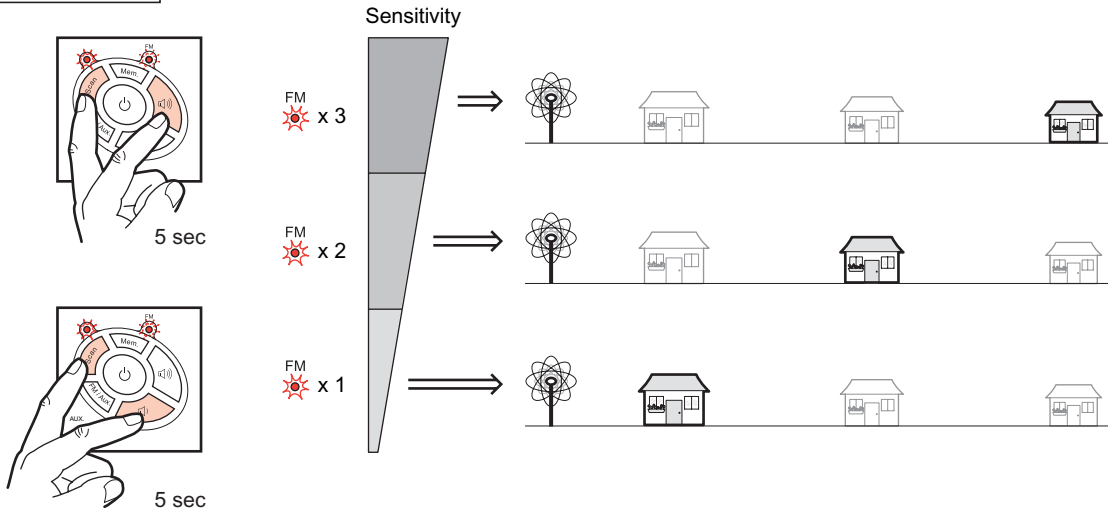

- If despite the settings the quality of reception remains bad, please contact us.
- Sollte nach ordnungsgemäßer Installation und Sendereinstellung die Qualität des Empfanges schlecht sein, kontaktieren Sie bitte Ihr Legrand Team.
- Si a pesar de los ajustes en la configuración, la recepción sigue siendo mala, por favor contacte con nuestro Servicio de Asistencia Técnica.
- Εάν μετά από τις ρυθμίσεις αυτές, η ποιότητα του ήχου που λαμβάνετε δεν είναι καλή, επικοινωνήστε μαζί μας.
- Ha a beállítás ellenére a hangminőség nem megfelelő, kérem lépjen velünk kapcsolatba.
- Jeżeli pomimo regulacji jakości odbioru jest zła, prosimy o kontakt.
- Se, após realização de todas as regulações, a qualidade de recepção não for satisfatória, consulte-nos para assistência.
- V prípade, že kvalita príjmu zůstane špatná i po provedených nastaveních, kontaktujte nás prosím.
- Если, несмотря на настройки пар амметров, качество приема остается плохим, пожалуйста свяжитесь с нами.
- Tüm ayarların yapıldıktan sonra, yayın kalitesi iyi değil ise lütfen bize danışınız.
- Ak aj napriek úpravám v nastaveniach zvuku zostane kvalita zvuku nedostatočná, prosím kontaktujte nás.
- Indien bij de juiste instellingen het kwaliteitsniveau slecht blijft, neem a.u.b. contact met ons op.
- Dacă toate aceste reglaje au fost realizate iar calitatea receptiei este slaba, va rugam sa ne contactati.
- Si malgré les réglages, la qualité de réception reste mauvaise, nous consulter.

