

Swifts® extra heavy duty (Emerald) cable ladder

lengths and fittings (continued)

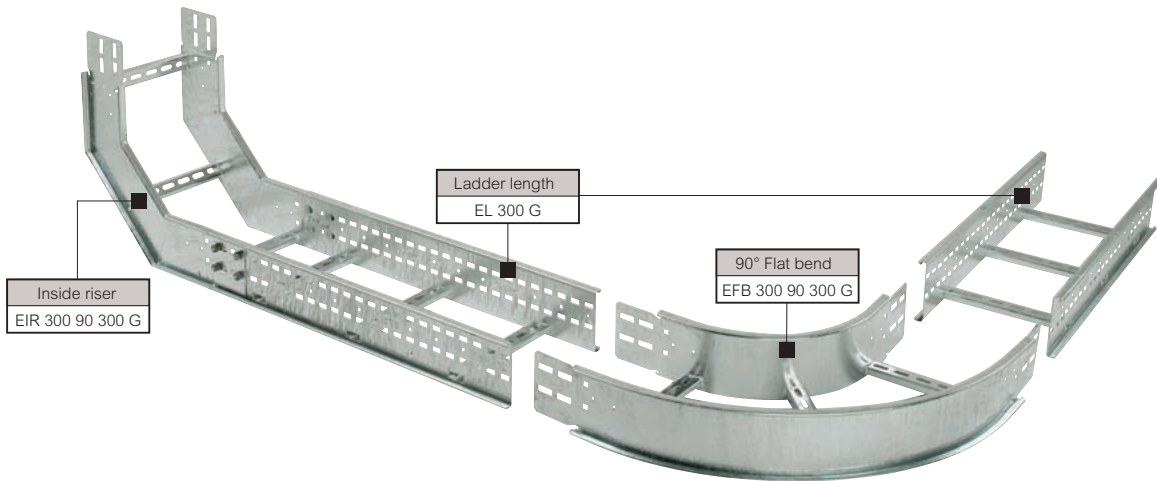
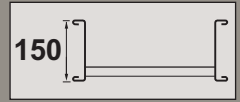

Selection chart (p. 10-11)
 Dimensions and technical information : lengths (p. 36) ; coupler sets (p. 38-45) ; fittings (p. 46-73)
 Design notes (p. 112)
 Loading graphs (p. 34)

When connecting fittings to straight lengths, use fastener sets (see opposite)

Rung spacing : 300 mm between centres
 Standard radius for fittings : 300 and 600 mm

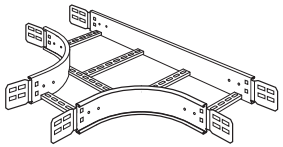
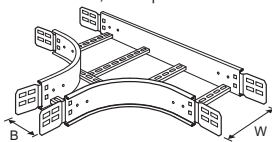
Pack	Cat. Nos.	Fittings (continued)
		Tees and crosspieces For all equal and unequal tees and crosspieces, include R in your ordering code to indicate radius dimension. See unequal tee example below. Larger width/radius combinations are supplied in two identical halves with fasteners
1	ETW ^r RF	Equal tees For technical information, see p. 62
		
1	EUTW ^B rRF	Unequal tees Example : the ordering code for a hot dip galvanised unequal tee with a 300 main run (W) and a 150 branch (B) with a 600R radius : PUT 300 150 600R G For technical information, see p. 63-68
		

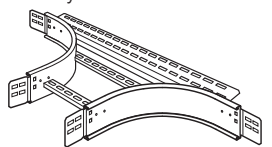
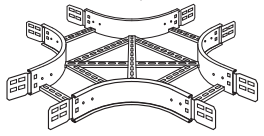
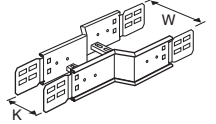
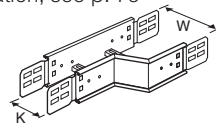
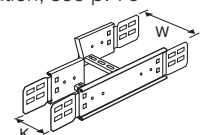
Pack	Cat. Nos.	Fittings (continued)
1	EB W 300 R F	Branch piece For technical information, see p. 69 Available in 300 R only
		
1	EXW ^r RF	4 way crosspieces For technical information, see p. 70-71
		
1	ESRWKF	Straight reducers For technical information, see p. 72
		
1	ELRWKF	Offset reducers – left hand For technical information, see p. 73
		
1	ERRWKF	Offset reducers – right hand For technical information, see p. 73
		

Standard dimensions and finishes

Key : selecting extra heavy duty (Emerald) fittings. Replace the letters shown in red with your choice from the following options :

- W = Widths (mm) : 150, 300, 450, 600, 750, 900
- A = Angle (°) : 90, 60, 45 or 30
- B = Branch width (mm) : 150, 300, 450, 600, 750, 900
- F = Finish : G (hot dip galvanised after manufacture), D (deep galvanised) S (stainless steel)
- K = Narrowed width when using a reducer (mm) : 150, 300, 450, 600, 750
- r = Radius (mm) : 300, 600

Dimensions and finishes available to special order

- Contact us on +44 (0) 845 605 4333
- Radius (r) (mm) : 450, 750 and 900
- Rungs : Type 2 or type 3
- Widths (W) (mm) : 200, 250, 350, 400, 500, 550, 650, 700, 800, 850 and 950
- Angles (°) : Available to customer's specification
- Finish (F) : Pickle and passivation on stainless steel