

## FIXATIONS DIVERSES

### SUPPORTS POUR LUMINAIRES ET BOÎTES DE DÉRIVATIONS

#### → SUPPORTS POUR BOÎTES DE DÉRIVATION - SBDN - SUBD

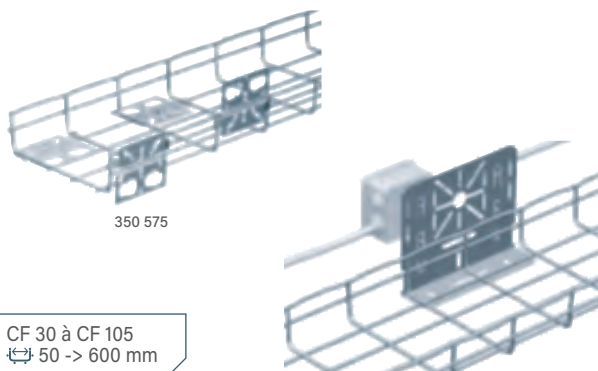

350 575

350 588

#### MONTAGE ET DIMENSIONS

##### SBDN

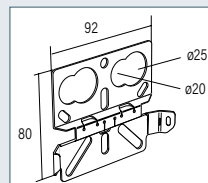

##### SUBD

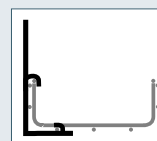
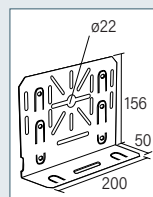

CF 30 à CF 105  
↳ 50 -> 600 mm

Emb.

**GS**

**HR**

**316L**

<b>SBDN</b>	10 P	350 575	350 576	350 577
<b>SUBD</b>	10 P	350 588	-	-

#### → CONSOLE CM50XXL



CF 30 à CF 105  
↳ 50 -> 600 mm

Pour fixation boîte ou connecteur  
Rabattre les pattes au montage

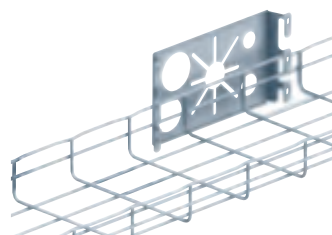

586 250

#### MONTAGE

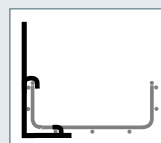

#### DIMENSIONS

##### CM50XXL

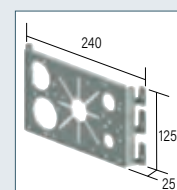

Couple  
(daN.m)

Emb.

**GS**

**ZnL**

<b>CM50XXL</b>	25	10 P	586 250	586 257
----------------	----	------	---------	---------

Vis : - 1 point de fixation jusqu'à la largeur 200 mm incluse  
- 2 points de fixation à partir de la largeur 300 mm



Consoles CM50 - CM50XL  
p. 190