

FIXATION MURALE

CHARGES LOURDES

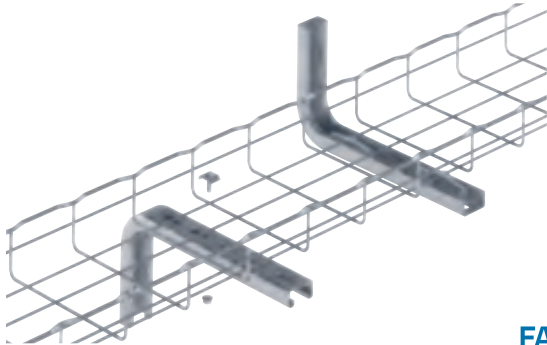

→ CONSOLES CINTRÉES CC21S



557 860

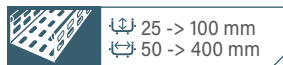

Consoles utilisables en pendard (p. 214)

Peut également être fixé :
- sur rail
- sur pendard

	Charge (daN)	L (mm)	Emb.	GS	316L
CC21S150	135	150	10 P	557 860	557 864
CC21S200	108	200	10 P	557 870	557 874
CC21S300	80	300	10 P	557 880	557 884
CC21S400	92	400	10 P	557 890	557 894

MONTAGE

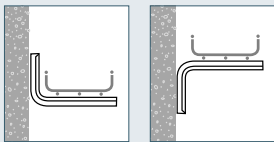

DIMENSIONS

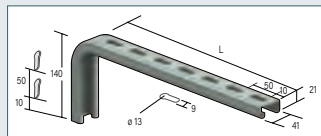

FIXATION

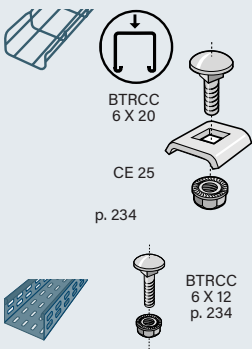

FASTRUT



++ Consoles plafond CCP21S p. 210

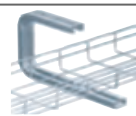

++ Embouts p. 214-215

Vis : - 1 point de fixation jusqu'à la largeur 200 mm incluse
- 2 points de fixation à partir de la largeur 300 mm
FS41 : 1 FS41 pour la largeur 50, 2 FS41 à partir de la largeur 100

→ CONSOLES C21S



1

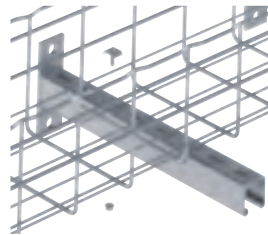

2

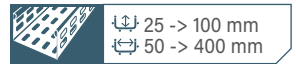

Peut également être fixé :
- sur rail
- sur pendard



	Charge (daN)	L (mm)	Emb.	GC
C21S150	250	200	24 P	597 013
C21S200	180	300	24 P	597 023
C21S300	130	400	20 P	597 033
C21S400	100	500	16 P	597 043

MONTAGE

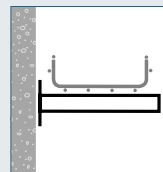

DIMENSIONS

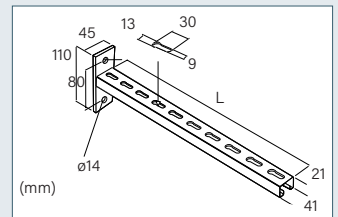

FIXATION

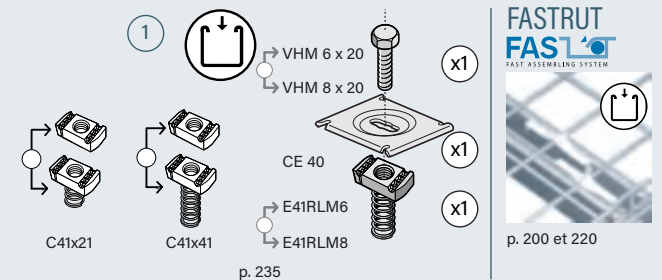
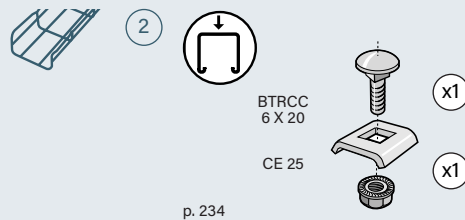
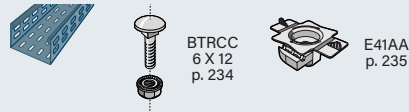

++ Rails R21 - R41 p. 208