

Floor boxes for carpet

technical characteristics

Dimensions

Modular backbox for raised floors

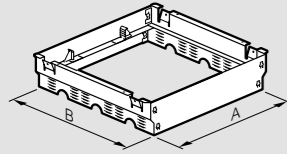

Cat.Nos	A (mm)	B (mm)	Use for trunking
6 896 39	263	263	225/300 x 38
6 896 49	263	340	225/300 x 38

Floor tile cutting

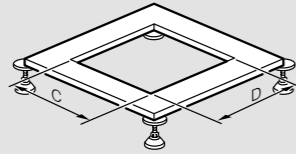

Cat.Nos	C (mm)	D (mm)
6 896 39	264	264
6 896 49	264	341

Backbox

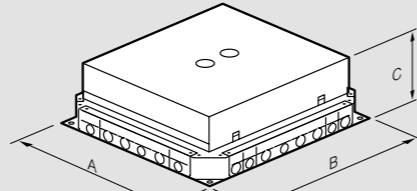

Cat.Nos	A (mm)	B (mm)	C (mm)
6 896 34	325	325	90
6 896 45	400	325	90

Dimensions for carpet cut out on backbox support frame

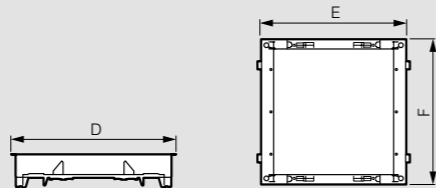

Cat.Nos	Carpet cut out		
	D (mm)	E (mm)	F (mm)
6 896 39	276	264	264
6 896 49	276	264	340

Modules

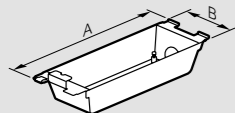

Modules in high position

Modules in low position

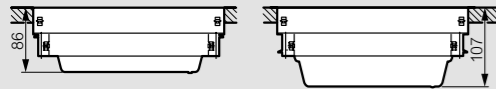

Cat.Nos	A (mm)	B (mm)
6 896 60 (single)	255	77
6 896 61 (double)	255	154

Installation principle

Lid and trim can be used for all applications: screed, flush and raised access floor systems. It allows a uniform finish within the project

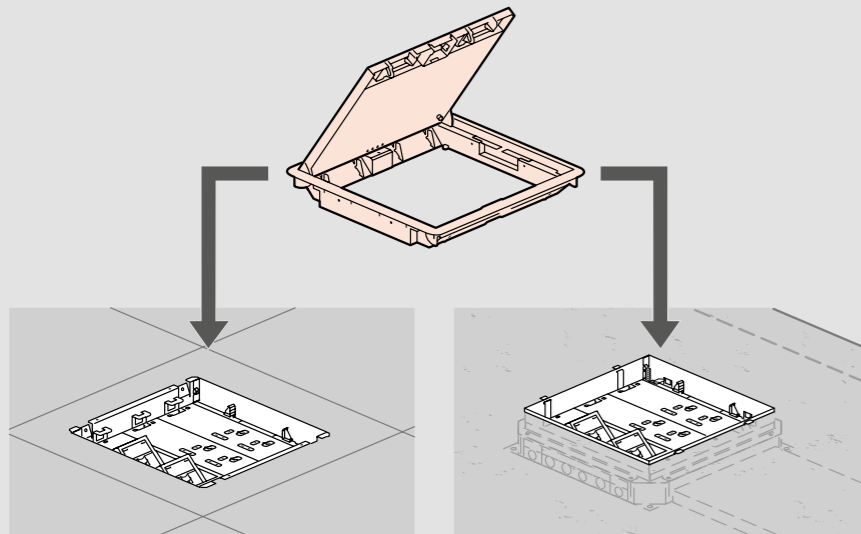

Rigid and flexible cable exits

Rigid and flexible cable exits: maximum cable capacity 4 cables $\varnothing 7$ mm + 3 cables $\varnothing 11$ mm. Both systems provide maximum protection for cables. Flexible exit does not require closing when not in use

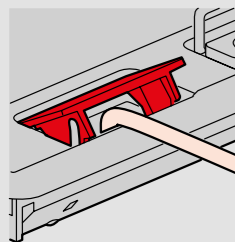

Rigid cable exits

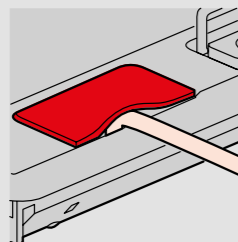

Soft cable exits

Site protection cover

Lid and trim comes with a building site protection to avoid damages during installation. This site protection should be removed to access the floor box and can be repositioned afterwards. Site protection cover should remain on the floor box until hand-over of the project

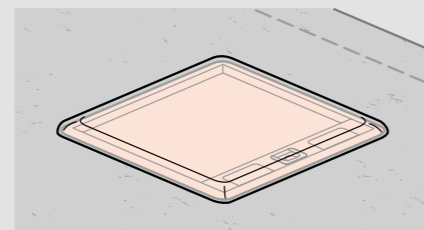

Reversible lid

The lid is reversible (180°) to adapt to office furniture reconfiguration

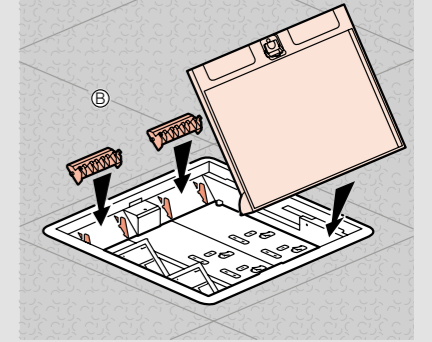
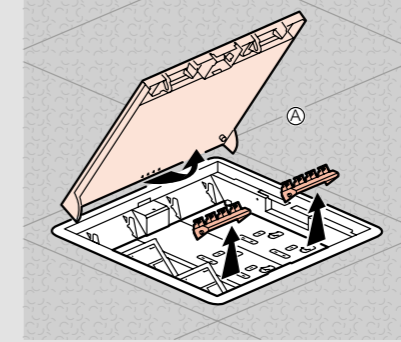
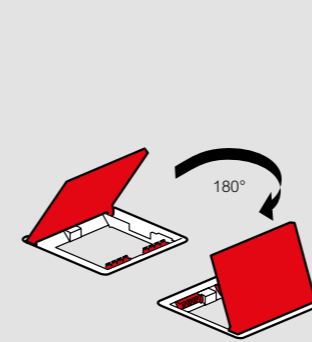

Locking system

The floor box can be locked by means of a locking system on the lid (hidden under the opening handle) For safety reasons, floor box should not be locked when in use

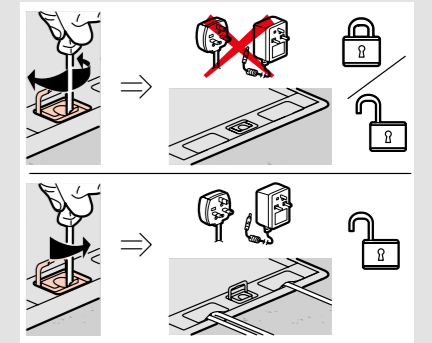
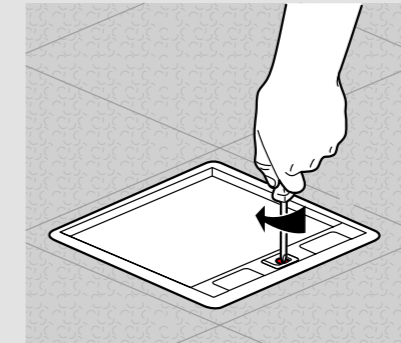
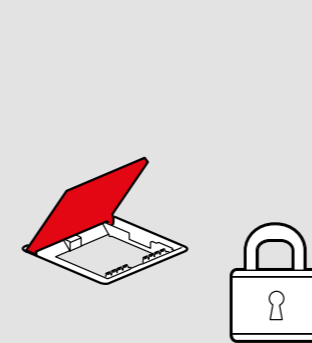

Installation process

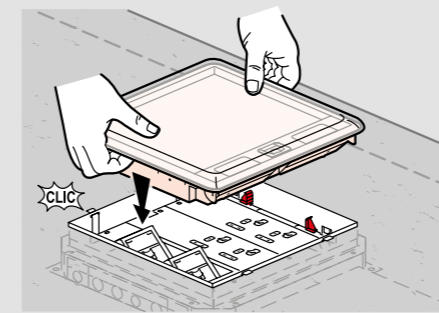

Fix the lid and trim directly onto the backbox, push and fit system Lid and trim can be assembled with backbox even before carpet fitting

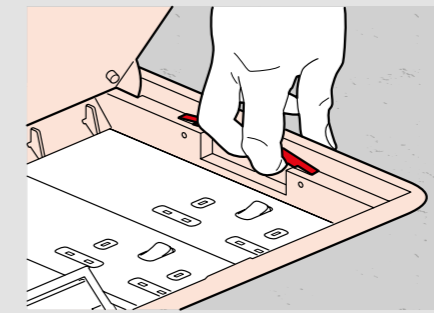

To fit carpet, pull the levers on both sides to take out the lid and trim

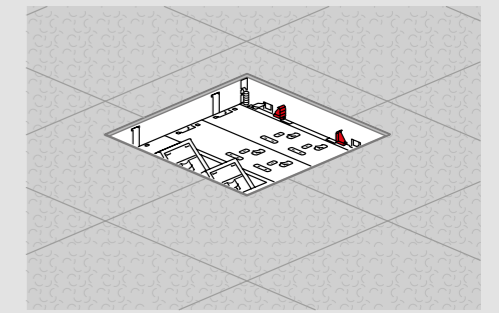

Fit the carpet to the backbox edge

Stainless steel insert	3 compt	4 compt
	6 896 92	6 896 93

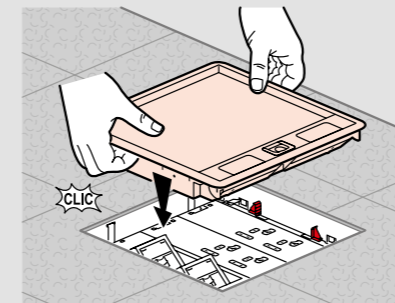

Push the lid and trim back on to the backbox The trim will adjust to the carpet thickness

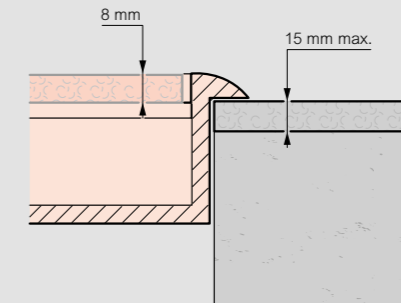

Carpet thickness < 15 mm

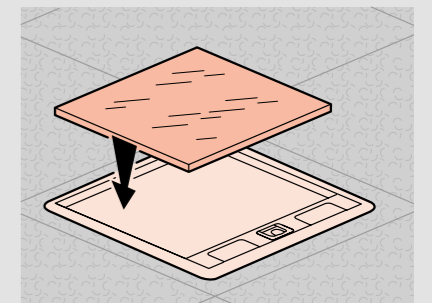

Stainless steel insert optional as an alternative to filling the lid with carpet To fit the stainless steel insert on to the lid, use the double side tape supplied