

DMX³ 2500, DMX³-I 2500, DMX³ 4000 and DMX³-I 4000 - frame 4000

dimensions

Fixed version - frame 4000

Overall dimensions

3P version

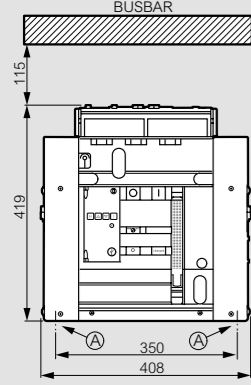

4P version

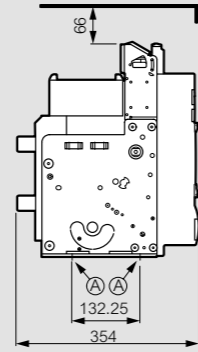
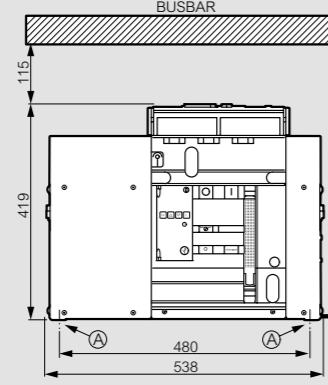

A = fixing point on plate of enclosure

Connection principle

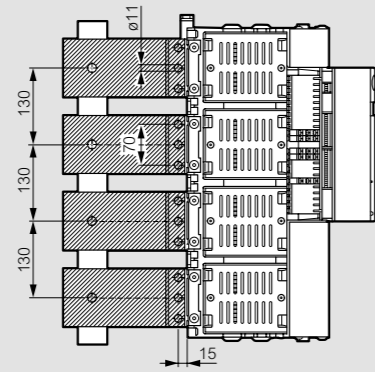
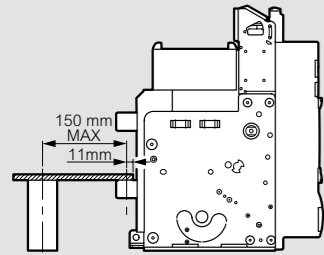

Rear terminals

3P version

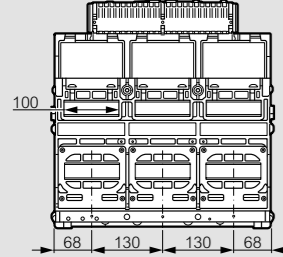

4P version

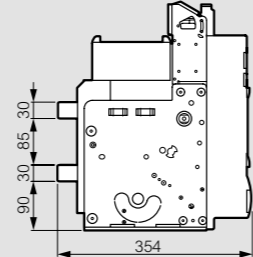
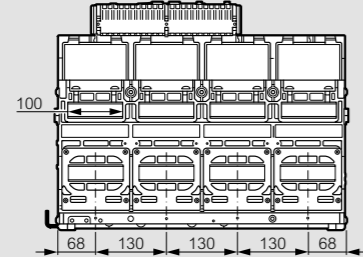

Draw-out version - frame 4000

Overall dimensions

3P version

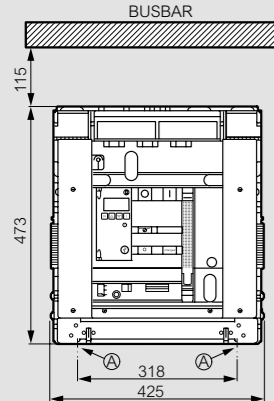

4P version

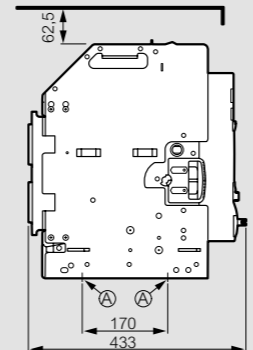
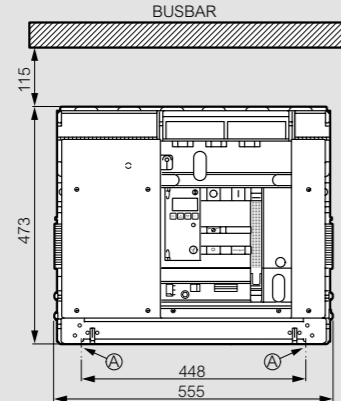

Draw-out version - frame 4000 (continued)

Rear terminals for flat connection with bars

3P version

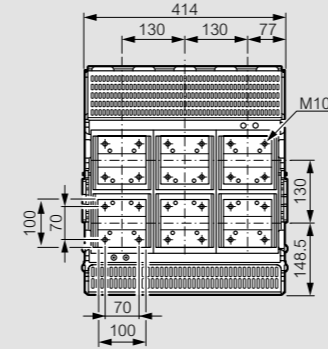

4P version

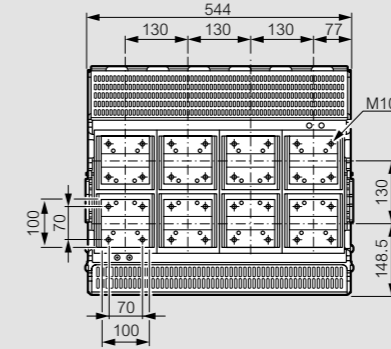

Rear terminals for horizontal connection with bars

Cat.Nos 0 288 92/93

3P version

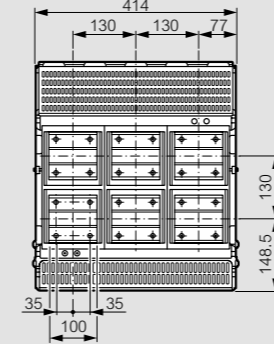

4P version

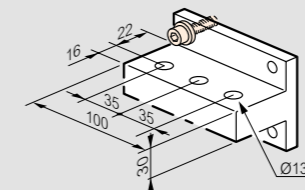
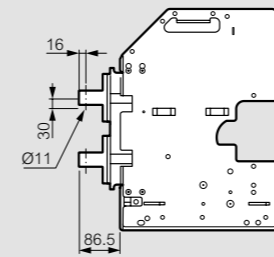
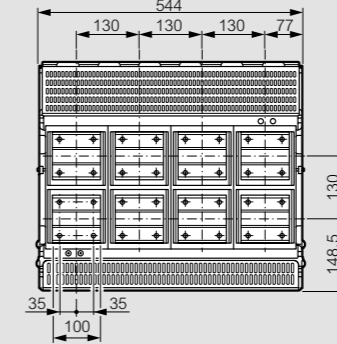

Rear terminals for vertical connection with bars

Cat.Nos 0 288 92/93

3P version

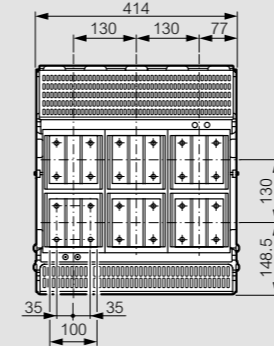

4P version

