

# Current transformers (CT)

## technical characteristics

### Dimensions

#### Single-phase solid core current transformers

Cat.Nos 4 121 01/02/03/04/05/06/07

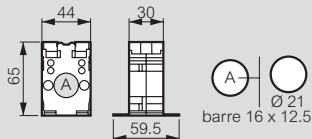

Cat.Nos 4 121 12/14

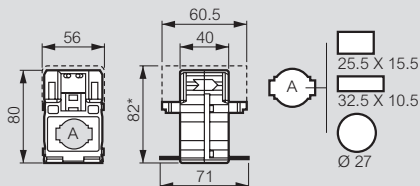

Cat.Nos 4 121 16/17/19

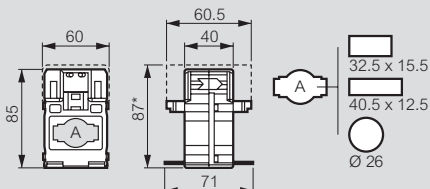

Cat.Nos 4 121 23/24/25/26

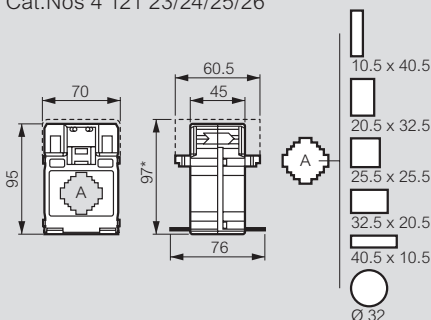

Cat.Nos 4 121 31/32/33

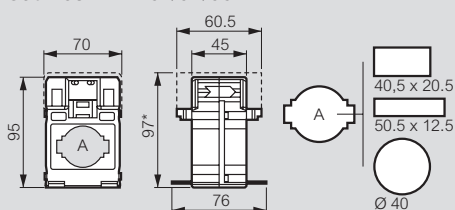

Cat.Nos 4 121 36/38/39/42/46/47/49/50/51/52/53/54

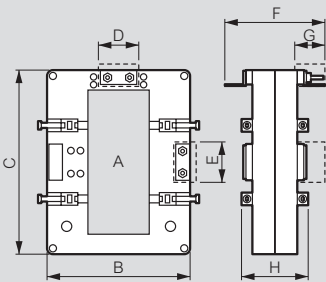

Cat.Nos	A	B	C	D	E	F	G	H
4 121 36/38/39	32 x 65	90	94	33,5	33,5	90	25	40
4 121 42	34 x 84	96	116	33,5	33,5	87	25	40
4 121 46/47/49	38 x 127	99	160	33,5	33,5	87	25	58
4 121 50/51/52/53/54	54 x 127	125	160	33,5	33,5	87	25	40

#### Single-phase split core current transformers

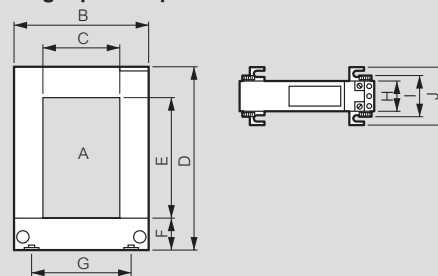

Cat.Nos	A	B	C	D	E	F	G	H	I	J
4 121 62/63	50 x 80	114	50	145	80	33	78	32	46	69
4 121 64/65	80 x 120	144	80	185	121	32	108	32	46	69
4 121 66/67/68/69	80 x 160	184	80	245	160	38	120	32	46	69

#### Three-phase solid core current transformers

Cat.No 4 121 57 for three 20,5 x 5,5 mm bars  
 Cat.No 4 121 58 for three 30,5 x 5,5 mm bars  
 For fixing directly on bars

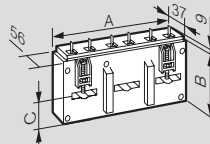

Cat.Nos	A	B	C
4 121 57	107	58,5	25
4 121 58	135	66,5	30

#### Maximum cable length between current transformers (CT) and meters

Size (A)	Cat.Nos	Max. output		Maximum cable length between current transformers & meters (m)		
		Class 0,5 (VA)	Class 1 (VA)	Cable 1,5mm <sup>2</sup>	Cable 2,5mm <sup>2</sup>	Cable 6mm <sup>2</sup>
50	4 121 01		1,25	1,1	1,8	4,4
75	4 121 02		1,5	1,5	2,4	5,9
100	4 121 03		2	2,2	3,7	8,9
125	4 121 04	2,5		2,9	4,9	11,8
160	4 121 05	3		3,7	6,1	14,8
200	4 121 06	4		5,1	8,5	20,7
250	4 121 07	5		6,6	11,0	26,6
400	4 121 12	10		13,9	23,2	56,2
600	4 121 14	12		16,8	28,1	68,1
250	4 121 16	3		3,7	6,1	14,8
400	4 121 17	6		8,0	13,4	32,6
700	4 121 19	8		11,0	18,3	44,4
250	4 121 23	3		3,7	6,1	14,8
300	4 121 24	5		6,6	11,0	26,6
400	4 121 25	8		11,0	18,3	44,4
600	4 121 26	12		16,8	28,1	68,1
700	4 121 31	8		11,0	18,3	44,4
800	4 121 32	8		11,0	18,3	44,4
1000	4 121 33	10		13,9	23,2	56,2
600	4 121 36	8		11,0	18,3	44,4
800	4 121 38	12		16,8	28,1	68,1
1000	4 121 39	15		21,2	35,4	85,8
1250	4 121 42	12		16,8	28,1	68,1
1600	4 121 46	10		13,9	23,2	56,2
2000	412 147	15		21,2	35,4	85,8
3200	4 121 49	25		35,8	59,8	145,0
1600	4 121 50	20		28,5	47,6	115,4
2000	4 121 51	25		35,8	59,8	145,0
2500	4 121 52	30		43,1	72,0	174,6
3200	4 121 53	30		43,1	72,0	174,6
4000	4 121 54	30		43,1	72,0	174,6
3 X 250	4 121 57		3	3,7	6,1	14,8
3 X 400	4 121 58		4	5,1	8,5	20,7
400	4 121 62	1,5		1,5	2,4	5,9
750	4 121 63	3		3,7	6,1	14,8
1000	4 121 64	5		6,6	11,0	26,6
1500	4 121 65	8		11,0	18,3	44,4
2000	4 121 66	15		21,2	35,4	85,8
2500	4 121 67	15		21,2	35,4	85,8
3000	4 121 68	20		28,5	47,6	115,4
4000	4 121 69	20		28,5	47,6	115,4