

IZYLUM



Designer : Indio da Costa



A time saving, versatile and high performance road and urban solution

Based on Schröder experience and proven track record with road and urban LED lighting, the IZYLUM luminaire benefits from numerous innovations to provide the ultimate experience for any stakeholder in the project - municipalities looking for a fast return on investment with an environmentally friendly, easy-to-operate lighting solution, contractors wanting to save time and avoid mistakes during installation, and citizens requiring safe and comfortable environments.

This connected-ready range of luminaires not only offers a realistic platform for smart cities; its compact, lightweight, optimised design minimises the carbon footprint at every stage of the product lifecycle. IZYLUM stands out as the best in class for a circular economy.

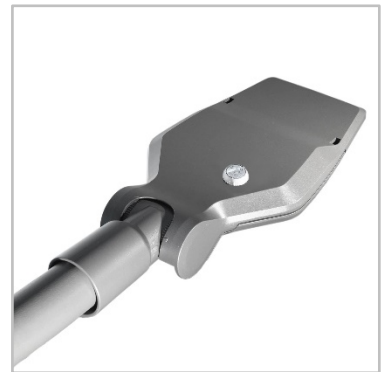

Concept

IZYLUM is a robust yet compact luminaire, designed with a focus on ease of installation and maintenance, enabling customers to extend its lifetime with future upgrades. Composed of two separate parts made of high-pressure die-casted aluminium, the body is sealed with tempered flat glass, offering a high degree of tightness and resistance to shocks.

Available in five sizes with a LED count of 10 to 240 LEDs, IZYLUM provides a well-dimensioned, efficient lighting solution ranging from various low-height applications such as parks, bicycle paths or residential streets to main roads, boulevards and motorways.

The IZYLUM range takes advantage of the latest photometric innovations. It uses the new LensoFlex®4 and MidFlex™2 photometric engines, which have been developed around the ideas of performance, compactness, versatility and standardisation. They both fit in the same product design, no matter which photometrical concept is preferred.

To simplify installation and maintenance operations, IZYLUM introduces patented technologies such as the IzyHub compact connection and connectivity module, for quick, error-proof wiring, and a new IzyFix universal fixation system enabling post-top or side-entry mounting. The luminaire offers tool-free access to the gear compartment. The bottom cover opens downwards and is retained by a hinge. Closing of the luminaire is confirmed with a clear, loud clicking noise, audible even in a noisy urban environment.

Supplied pre-wired (optional), IZYLUM is adapted to post-top and side-entry mounting on any spigot (Ø32mm, Ø42-48mm, Ø60mm and Ø76mm). The IzyFix system enables switching from one position to another at any time, without removing the luminaire from the pole. This unique feature eases installation and offers complete versatility regarding pole and bracket configurations.

The IzyFix system enables tilting within a 130° range and fully complies with IEC and ANSI 3G vibration standards.



IZYLUM introduces two new highly efficient photometrical platforms.



The IzyFix universal fixation system with switching from a post-top to a side-entry position facilitates luminaire ordering and installation.

TYPES OF APPLICATION

- URBAN & RESIDENTIAL STREETS
- BRIDGES
- BIKE & PEDESTRIAN PATHS
- RAILWAY STATIONS & METROS
- CAR PARKS
- SQUARES & PEDESTRIAN AREAS
- ROADS & MOTORWAYS

KEY ADVANTAGES

- Maximised savings in energy and maintenance costs
- New generation of LensoFlex®4 and MidFlex™2 photometric engines offering high-efficiency lighting, comfort and safety
- 5 sizes to provide the most accurate solution for numerous road and urban applications
- Tool-free access with a clear confirmative click upon closing
- Fast and error-proof installation and maintenance with IzyHub
- On-site adjustment from post-top to side-entry without disconnecting the luminaire from the pole thanks to IzyFix
- Wide range of operating temperatures
- Zhaga-D4i certified
- Connected-ready

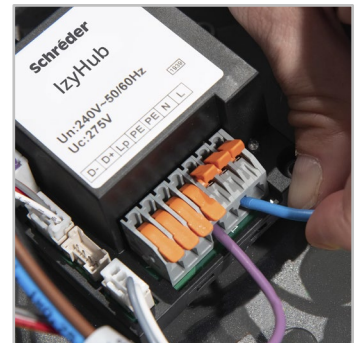

The failure-proof IzyHub module eases electrical connection on installation and during maintenance operations.



IZYLUM is connected-ready and can operate with various sensors and control systems.



LensoFlex®4

LensoFlex®4 maximises the heritage of the LensoFlex® concept with a very compact yet powerful photometric engine based upon the addition principle of photometric distribution. The number of LEDs in combination with the driving current determines the intensity level of the light distribution. With optimised light distributions and very high efficiency, this fourth generation enables the products to be downsized to meet application requirements with an optimised solution in terms of investment.

LensoFlex®4 optics can feature backlight control to prevent intrusive lighting, or a glare limiter for high visual comfort.

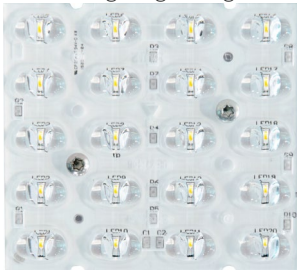

MidFlex™2

The second-generation MidFlex™2 photometric engine takes advantage of the latest generation of mid-power LEDs and dedicated optics for professional applications.

Designed to have the same footprint and fixations as the LensoFlex®4, the MidFlex™2 platform provides an alternative solution for those who are looking for very cost-effective yet efficient lighting while keeping the same luminaire design.



Back Light control

As an option, the LensoFlex®2 and LensoFlex®4 modules can be equipped with a Back Light control system.

This additional feature minimises light spill from the back of the luminaire to avoid intrusive light towards buildings.

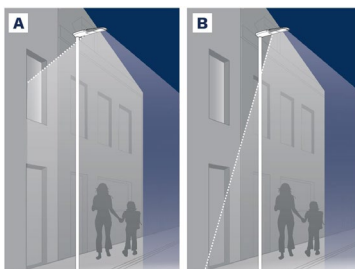

A. Without Back Light control | B. With Back Light control



Embellishment plate

This accessory not only provides a more aesthetic solution as it covers the wires supplying the PCBA's with power, it also increases the lumen output thanks to its extra bright surface that reflects light out of the optical unit. Depending on the configuration, the embellishment plate can increase the lumen output by 2 to 3%.





Diamond cooling blocks

IZYLUM 5 features newly developed cooling blocks on the upper side of the optical compartment. Their diamond shape has been carefully designed to minimise dust and water accumulation while providing optimal thermal management to maintain performance over time.





Constant Light Output (CLO)

This system compensates for the depreciation of luminous flux to avoid excess lighting at the beginning of the installation's service life. Luminous depreciation over time must be taken into account to ensure a predefined lighting level during the luminaire's useful life.

Without a CLO feature, this simply means increasing the initial power upon installation in order to make up for luminous depreciation. By precisely controlling the luminous flux, the energy needed to reach the required level can be maintained throughout the luminaire's life.

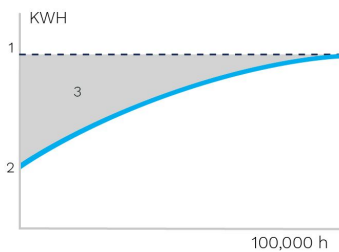

1. Standard lighting level | 2. LED lighting consumption with CLO | 3. Energy savings



Custom dimming profile

Intelligent luminaire drivers can be programmed with complex dimming profiles. Up to five combinations of time intervals and light levels are possible. This feature does not require any extra wiring.

The period between switching on and switching off is used to activate the preset dimming profile. The customised dimming system generates maximum energy savings while respecting the required lighting levels and uniformity throughout the night.

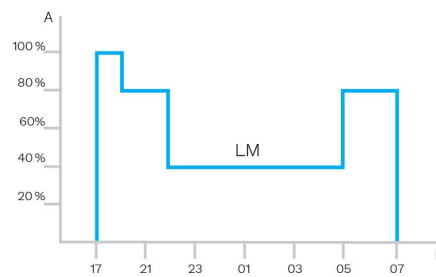

A. Dimming level | B. Time



PIR sensor: motion detection

In places with little nocturnal activity, lighting can be dimmed to a minimum most of the time. By using passive infrared (PIR) sensors, the level of light can be raised as soon as a pedestrian or a slow vehicle is detected in the area.

Each luminaire level can be configured individually with several parameters such as minimum and maximum light output, delay period and ON/OFF duration time. PIR sensors can be used in an autonomous or interoperable network.





The Schröder IzyFix patented high-pressure die-casted aluminium universal fixation system is an integral part of the luminaire mounted in the factory. The IzyFix system aims to fit needs worldwide by meeting IEC and ANSI 3G testing requirements. It is intended to simplify life for customers and installers in the process of purchasing and installing luminaires for various applications.

From post-top to side-entry in one movement

The innovative design allows changing from a side-entry to a post-top position – even with luminaires ordered with factory pre-cabling – without any switching work on the fixation or disconnection from the pole. Therefore the type of mounting (horizontal or vertical) does not have to be considered when ordering. This unique feature also eases installation. After setting the correct position, an accessory is provided to cover the resulting space and ensure further protection of the luminaire.

Best-in-class tilting range

The IzyFix universal fixation system enables a best-in-class range of mounting angle of 130°, to ensure maximum lighting performance for all kinds of road scenarios and offer the possibility of installing the luminaire in extreme situations as well. With a setting mark on the body and angles on the spigot, adjusting is carried out in 5° increments by loosening two screws. The wide tilting range enables more comfortable access to the gear compartment during field maintenance.

Variation for all poles

Due to the many different applications used worldwide, Schröder has created a range of fixation systems and reducers to satisfy all needs that might come up on the market.

IzyFix Ø60mm - suitable for:

- Ø32mm spigot (with reducer)
- Ø42-48mm spigot
- Ø60mm spigot

IzyFix Ø76mm - suitable for:

- Ø32mm spigot (with reducer)
- Ø42-48mm spigot (with reducer)
- Ø60mm spigot
- Ø76mm spigot

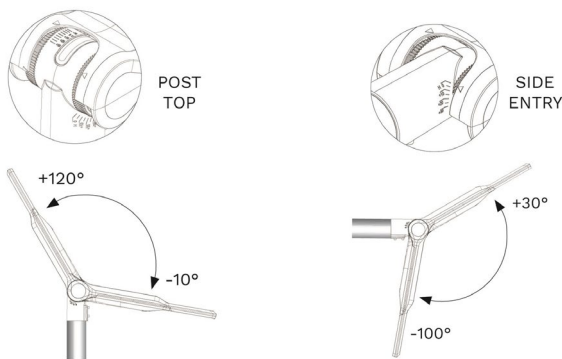
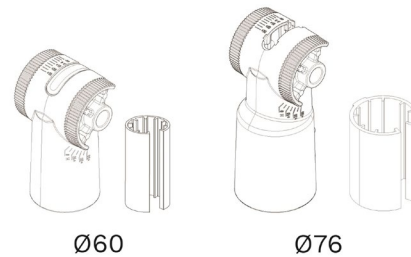

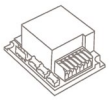

IzyHub

IzyHub is an innovative device that aims to keep luminaire installation and maintenance hassle-free. This single central connection hub distributes electricity and control information to all parts of the luminaire, ensuring that all components work together and offering reliable, long-term performance.

Its compact size and error-proof connections enable smaller and lighter luminaires that are easier to maintain and upgrade.



Surge Protection

IzyHub features a built-in surge protection device. This prevents electrical surges resulting from lightning strikes and other transient voltages that originate from the mains network from damaging the luminaire, even in the most demanding conditions. The protective device also includes an end-of-life LED warning light, indicating that the luminaire is protected correctly.

User-friendly

Installing a luminaire has never been easier. IzyHub features tool-free connector as the main connection terminal. It enables 30% shorter installation times compared with standard solutions. Lever actuated spring-loaded electrical connectors provide optimal contact throughout the entire life of the product.

Easy maintenance

On the rare occasion that a component needs to be replaced in the luminaire, IzyHub makes sure that operations are carried out quickly and easily. Luminaire component connections are keyed so that mixing up electrical connections is physically impossible. Installers do not need to trace wires individually: plug it in, and it works straight away.

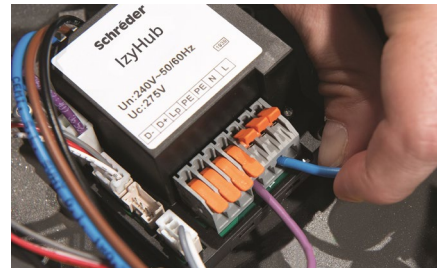

Versions and upgrades

IzyHub has several versions featuring different connectivity. IzyHub can include an SPD, can work with external dimming and operate with all type of control sockets. It is also able to provide bi-power control and to include fuse options.

These options provide flexibility for future upgrades by only having to replace the IzyHub to connect the new equipment. No complicated re-wiring needed.

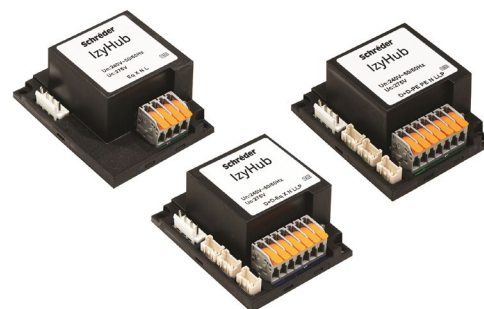

The Schröder Bluetooth solution consists of 3 main components:

- A Bluetooth dongle plugged into the modular driver of the luminaire (BLE transceiver)
- A Bluetooth antenna fitted on the luminaire
- A smartphone application called Sirius BLE



Easy to use

The Schröder Bluetooth solution is ideal for the on-site configuration of individual outdoor luminaires using Bluetooth. From the ground, the user is able to switch the luminaire on or off, adapt the dimming curve, read diagnostic data and much more. A user-friendly application called Sirius BLE provides an easy and secure access to the control and configuration functions.

Whether you are managing a lighting network in an urban or a residential area, this solution will make it easy to control your outdoor luminaires while simply standing by the pole.

Quick and easy pairing

Get the Sirius App from Schröder. Go to the menu. Press the “SCAN DEVICE (START)” button, to search for the surrounding BLE modules. They will be displayed with a bar graphic (signal intensity) to indicate the closest and the most distant one you can reach. Click on the device you want to connect to and enter your personal access key to control the luminaire.

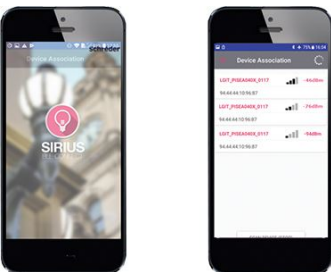

Defining the settings

Once you are connected to a luminaire, you can set various parameters such as the maximum output current, minimum dimming level and custom dimming profile.

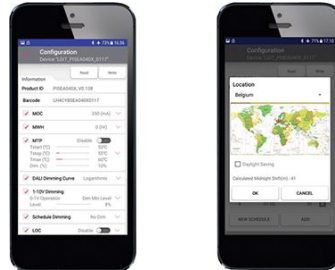

Manual dimming control

The App enables you to do a manual override to adapt the dimming levels instantly. Simply tap on the “Dimming” button in the main menu and adjust the dimming using the wheel and button. Predefined dimming levels can be applied immediately. The corresponding value is displayed on the wheel. This enables you to test the ON / OFF and dimming features of the luminaire paired to the smartphone.



On-site diagnostic

When a luminaire is paired, you can access various diagnostic information: total number of power up events, operation time of LED module and driver, total energy consumption of LED driver... etc. You can also track operating events (short circuits, thermal shutdowns...). The diagnostic values may be the current state or values accumulated to date.

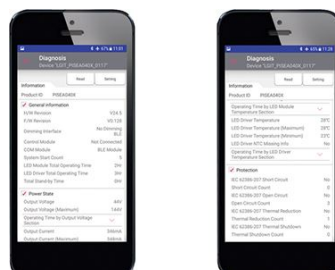

Owlet IoT

Owlet IoT remotely controls luminaires in a lighting network, creating opportunities for improved efficiency, accurate real-time data and energy savings of up to 85%.



ALL-IN-ONE

The LUCO P7 CM controller includes the most advanced features for optimised asset management. It also provides an integrated photocell and operates with an astronomical clock for seasonal dimming profile adaptations.

EASY TO DEPLOY

Thanks to wireless communication, no cabling is needed. The network is not subject to physical constraints or limitations. From a single control unit to an unlimited network, you can expand your lighting scheme at any time. With real-time geolocation and automatic detection of luminaire features, commissioning is quick and easy.

USER-FRIENDLY

Once a controller is installed on a luminaire, the luminaire automatically appears with its GPS coordinates on a web-based map.

An easy-to-use dashboard enables each user to organise and customise screens, statistics and reports. Users can gain relevant, real-time insights.

The Owlet IoT web application can be accessed at all times from anywhere in the world with a device connected to the Internet. The application adapts to the device to offer an intuitive and user-friendly experience.

Real-time notifications can be pre-programmed to monitor the most important elements of the lighting scheme.

SECURE

The Owlet IoT system uses a local wireless mesh communication networks to control the on-site luminaires combined with a remote control system utilising the cloud to ensure smooth data transfers to and from the central management system.

The system uses encrypted IP V6 communication to protect data transmission in both directions. Using a secure APN, Owlet IoT ensures a high level of protection.

In the exceptional case of a communication failure, the built-in astronomical clock and photocell will take over to switch the luminaires on and off, thus avoiding a complete blackout at night.

EFFICIENT

Thanks to sensors and/or pre-programmed settings, lighting scenarios can be easily adapted to cope with live events, providing the right lighting levels at the right time and in the right place.

The integrated utility grade meter offers the highest accuracy available on the market today, enabling decisions based on real figures.

Accurate real-time feedback and clear reporting ensures that the network operates efficiently and maintenance is optimised.

When LED luminaires are switched on, the inrush current can create problems for the electricity grid. Owlet IoT incorporates an algorithm to preserve the grid at all times.

OPEN

The LUCO P7 CM controller can be plugged onto the standard 7 pin NEMA socket and operates through either a DALI or 1-10V interface to control the luminaire.

Owlet IoT is based on the IPv6 protocol. This method for addressing devices can generate an almost unlimited number of unique combinations to connect non-traditional components to the Internet or computer network.

Through open APIs, Owlet IoT can be integrated into existing or future global management systems.



The Zhaga consortium joined forces with the DiiA and produced a single Zhaga-D4i certification that combines the Zhaga Book 18 version 2 outdoor connectivity specifications with the DiiA's D4i specifications for intra-luminaire DALI.

Standardisation for interoperable ecosystems

As a founding member of the Zhaga consortium, Schröder has participated in the creation of, and therefore supports, the Zhaga-D4i certification program and the initiative of this group to standardise an interoperable ecosystem. The D4i specifications take the best of the standard DALI2 protocol and adapt it to an intra-luminaire environment but it has certain limitations. Only luminaire mounted control devices can be combined with a Zhaga-D4i luminaire. According to the specification, control devices are limited respectively to 2W and 1W average power consumption.

Certification program

The Zhaga-D4i certification covers all the critical features including mechanical fit, digital communication, data reporting and power requirements within a single luminaire, ensuring plug-and-play interoperability of luminaires (drivers) and peripherals such as connectivity nodes.

Cost-effective solution

A Zhaga-D4i certified luminaire includes drivers offering features that had previously been in the control node, like energy metering, which has in turn simplified the control device therefore reducing the price of the control system.

2 sockets: top and bottom

The Zhaga socket is small and suited to applications where aesthetics is essential. The architecture of Zhaga-D4i also foresees the possibility of putting two sockets on one luminaire, allowing for instance, the combination of a detection sensor and a control node. This also has the added value of standardising certain detection sensor communications with the D4i protocol.

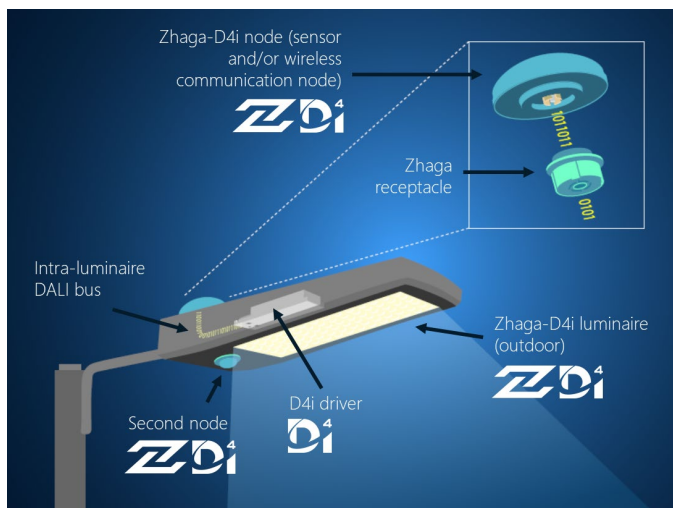

GENERAL INFORMATION

Recommended installation height	4m to 15m 13' to 49'
Circle Light label	Score >90 - The product fully meets circular economy requirements
Driver included	Yes
CE mark	Yes
ENEC certified	Yes
ENEC+ certified	Yes
ROHS compliant	Yes
BE 005 certified	Yes
Testing standard	LM 79-08 (all measurements in ISO17025 accredited laboratory) LM 80 (all measurements in ISO17025 accredited laboratory) EN 60598-1:2015+A1:2018 EN 60598-2-13:2006+A1:2012+A2:2016 EN 62262:2002 IEC TR 62778:2014

HOUSING AND FINISH

Housing	Aluminium
Optic	PMMA
Protector	Tempered glass
Housing finish	Polyester powder coating
Standard colour(s)	AKZO grey 900 sanded
Tightness level	IP66/IP67
Impact resistance	IK 09
Vibration test	Compliant with ANSI C 136-31 standard, 3G load and modified IEC 68-2-6 (0.5G)
Access for maintenance	Tool-less access to gear compartment

· Any other RAL or AKZO colour upon request

OPERATING CONDITIONS

Operating temperature range (Ta)	-40°C up to +55°C / -40°F up to 131°F with wind effect
----------------------------------	--

· Depending on the luminaire configuration. For more details, please contact us.

ELECTRICAL INFORMATION

Electrical class	Class I EU, Class II EU
Nominal voltage	220-240V – 50-60Hz
Power factor (at full load)	0.95+
Surge protection options (kV)	6 8 10
Electromagnetic compatibility (EMC)	EN 55015:2013/A1:2015, EN 61000-3-2:2014, EN 61000-3-3:2013, EN 61547:2009, EN 62493:2015
Control protocol(s)	Bluetooth, 1-10V, DALI
Control options	AmpDim, Bi-power, Custom dimming profile, Photocell, Remote management
Socket	Optional Zhaga socket - Zhaga-D4i certified product NEMA 7-pin (optional)
Associated control system(s)	Sirius BLE Owlet Nightshift Owlet IoT
Sensor	PIR (optional)

OPTICAL INFORMATION

LED colour temperature	2200K (Warm White 722) 2700K (Warm White 727) 3000K (Warm White 730) 3000K (Warm White 830) 4000K (Neutral White 740)
Colour rendering index (CRI)	>70 (Warm White 722) >70 (Warm White 727) >70 (Warm White 730) >80 (Warm White 830) >70 (Neutral White 740)
Upward Light Output Ratio (ULOR)	0%

LIFETIME OF THE LEDS @ TQ 25°C

All configurations	60,000h - L80 (mid-power LEDs) 100,000h - L95 (high-power LEDs)
--------------------	--

· Lifetime may be different according to the size/configurations. Please consult us.

DIMENSIONS AND MOUNTING

AxBxC (mm inch)	IZYLUM 1 - 587x94x294 23.1x3.7x11.6
	IZYLUM 2 - 604x94x352 23.8x3.7x13.9
	IZYLUM 3 - 715x94x368 28.1x3.7x14.5
	IZYLUM 4 - 873x94x390 34.4x3.7x15.4
	IZYLUM 5 - 873x94x390 34.4x3.7x15.4

Weight (kg lbs)	IZYLUM 1 - 4.9 10.8
	IZYLUM 2 - 6.3 13.9
	IZYLUM 3 - 7 15.4
	IZYLUM 4 - 9.9 21.8
	IZYLUM 5 - 10.3 22.7

Aerodynamic resistance (CxS)	IZYLUM 1 - 0.03
	IZYLUM 2 - 0.03
	IZYLUM 3 - 0.03
	IZYLUM 4 - 0.03
	IZYLUM 5 - 0.03

Mounting possibilities	Side-entry slip-over – Ø32mm
	Side-entry slip-over – Ø42mm
	Side-entry slip-over – Ø48mm
	Side-entry slip-over – Ø60mm
	Post-top slip-over – Ø32mm
	Post-top slip-over – Ø42mm
	Post-top slip-over – Ø48mm
	Post-top slip-over – Ø76mm

· Dimensions given for IZYLUM with Ø60mm spigot (side-entry mounting)

· Size and weight may be different according to the configuration. Please consult us for more information.

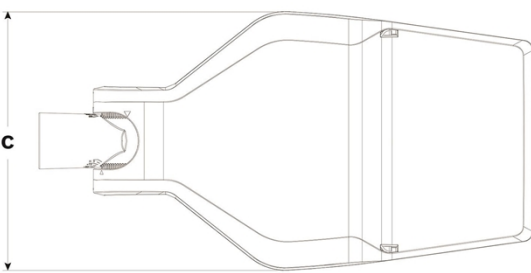
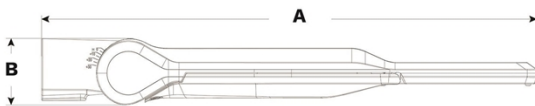



Luminaire	Number of LEDs	Current (mA)	Luminaire output flux (lm) Warm White 722		Luminaire output flux (lm) Warm White 727		Luminaire output flux (lm) Warm White 730		Luminaire output flux (lm) Warm White 830		Luminaire output flux (lm) Neutral White 740		Power consumption (W)	Luminaire efficacy (lm/W)	Photometry
			Min	Max	Min	Max	Min	Max	Min	Max	Min	Max			
IZYLUM 1	10	200	600	700	700	800	800	900	700	800	800	1000	7.2	139	
	10	300	800	1000	1100	1200	1100	1300	1100	1200	1200	1400	10.5	133	
	10	350	1000	1100	1200	1400	1300	1500	1200	1400	1400	1600	12.1	132	
	10	400	1100	1300	1400	1600	1500	1700	1400	1600	1600	1800	13.8	130	
	10	450	1200	1400	1500	1800	1600	1900	1500	1800	1700	2000	15.4	130	
	10	500	1300	1600	1700	2000	1800	2100	1700	2000	1900	2200	17.1	129	
	10	550	1400	1700	1800	2100	1900	2300	1800	2100	2000	2400	19	126	
	10	600	1500	1800	1900	2300	2100	2500	1900	2300	2200	2600	20.9	124	
	10	700	1700	2100	2200	2600	2300	2800	2200	2600	2500	2900	23.6	123	
	10	800	1900	2300	2400	2900	2600	3100	2400	2900	2800	3300	26.9	123	
	10	900	2200	2600	2700	3200	2900	3400	2700	3200	3100	3600	30.4	118	
	10	1000	2300	2700	2900	3400	3000	3600	2900	3400	3200	3800	34.1	111	
	20	200	1200	1400	1500	1700	1600	1900	1500	1700	1700	2000	13.1	153	
	20	300	1700	2000	2200	2500	2300	2700	2200	2500	2400	2900	19.3	150	
	20	350	2000	2300	2500	2900	2600	3100	2500	2900	2800	3300	22.4	147	
	20	400	2200	2600	2800	3300	3000	3500	2800	3300	3200	3700	25.6	145	
	20	450	2500	2900	3100	3700	3300	3900	3100	3700	3500	4100	28.8	142	
	20	500	2700	3200	3400	4000	3600	4300	3400	4000	3800	4500	32.1	140	
20	550	2900	3500	3700	4300	3900	4600	3700	4300	4100	4900	35.4	138		

Tolerance on LED flux is ± 7% and on total luminaire power ± 5 %



Luminaire	Number of LEDs	Current (mA)	Luminaire output flux (lm) Warm White 722		Luminaire output flux (lm) Warm White 727		Luminaire output flux (lm) Warm White 730		Luminaire output flux (lm) Warm White 830		Luminaire output flux (lm) Neutral White 740		Power consumption (W)	Luminaire efficacy (lm/W)	Photometry
			Min	Max	Min	Max	Min	Max	Min	Max	Min	Max			
IZYLUM 1	20	600	3100	3700	3900	4700	4200	5000	3900	4700	4400	5200	38.8	134	
	20	700	3500	4200	4500	5200	4700	5600	4500	5200	5000	5900	45.5	130	
	20	800	3900	4600	4900	5800	5300	6200	4900	5800	5600	6600	51.5	128	
	20	900	4300	5100	5400	6300	5700	6800	5400	6300	6100	7100	58	122	
	20	1000	4600	5400	5800	6800	6100	7200	5800	6800	6500	7600	65	117	
	40	40	-	-	-	-	1300	1500	-	-	1400	1600	10.9	147	
	40	60	-	-	-	-	2000	2200	-	-	2100	2300	15.9	145	
	40	75	-	-	-	-	2400	2700	-	-	2600	2900	19.8	146	
	40	90	-	-	-	-	2900	3100	-	-	3100	3400	23.8	143	
	40	105	-	-	-	-	3300	3600	-	-	3600	3900	28	139	
	40	110	-	-	-	-	3500	3800	-	-	3700	4100	29.4	139	
	40	120	-	-	-	-	3700	4100	-	-	4000	4400	32.3	136	
	40	135	-	-	-	-	4100	4500	-	-	4400	4800	36.7	131	
	40	140	-	-	-	-	4300	4600	-	-	4600	5000	38.1	131	
	40	160	-	-	-	-	4700	5200	-	-	5100	5500	43.5	126	
	40	180	-	-	-	-	5200	5700	-	-	5600	6100	49.5	123	
40	200	-	-	-	-	5600	6100	-	-	6000	6600	55.5	119		











Tolerance on LED flux is ± 7% and on total luminaire power ± 5%



Luminaire	Number of LEDs	Current (mA)	Luminaire output flux (lm) Warm White 722		Luminaire output flux (lm) Warm White 727		Luminaire output flux (lm) Warm White 730		Luminaire output flux (lm) Warm White 830		Luminaire output flux (lm) Neutral White 740		Power consumption (W)	Luminaire efficacy (lm/W)	Photometry
			Min	Max	Min	Max	Min	Max	Min	Max	Min	Max			
IZYLUM 2	30	200	1800	2100	2200	2600	2400	2800	2200	2600	2500	3000	18.6	161	
	30	300	2600	3100	3200	3800	3400	4100	3200	3800	3600	4300	28	154	
	30	350	2900	3500	3700	4400	3900	4700	3700	4400	4200	5000	32.5	154	
	30	400	3300	3900	4200	5000	4400	5300	4200	5000	4700	5600	37.1	151	
	30	450	3700	4400	4600	5500	4900	5800	4600	5500	5200	6200	42	148	
	30	500	4000	4800	5000	6000	5400	6400	5000	6000	5700	6700	47	143	
	30	550	4300	5200	5500	6500	5800	6900	5500	6500	6100	7300	51.5	142	
	30	600	4700	5600	5900	7000	6200	7400	5900	7000	6600	7900	56.5	140	
	30	700	5300	6300	6600	7900	7100	8400	6600	7900	7500	8900	64.5	138	
	30	800	5800	7000	7300	8700	7800	9300	7300	8700	8300	9800	75	131	
	30	870	6200	7400	7800	9300	8300	9900	7800	9300	8800	10500	84	125	
	40	200	2400	2800	3000	3500	3200	3800	3000	3500	3300	4000	24.3	165	
	40	300	3400	4100	4300	5100	4600	5500	4300	5100	4800	5800	37	157	
	40	350	3900	4700	5000	5900	5300	6300	5000	5900	5600	6700	42.5	158	
	40	400	4400	5300	5600	6600	5900	7100	5600	6600	6300	7500	49	153	
	40	450	4900	5800	6200	7300	6600	7800	6200	7300	6900	8300	55	151	
	40	500	5400	6400	6700	8000	7200	8500	6700	8000	7600	9000	61.5	146	
	40	550	5800	6900	7300	8700	7800	9300	7300	8700	8200	9800	68	144	

Tolerance on LED flux is ± 7% and on total luminaire power ± 5 %



Luminaire	Number of LEDs	Current (mA)	Luminaire output flux (lm) Warm White 722		Luminaire output flux (lm) Warm White 727		Luminaire output flux (lm) Warm White 730		Luminaire output flux (lm) Warm White 830		Luminaire output flux (lm) Neutral White 740		Power consumption (W)	Luminaire efficacy (lm/W)	Photometry
			Min	Max	Min	Max	Min	Max	Min	Max	Min	Max			
IZYLUM 2	40	600	6200	7400	7800	9300	8300	9900	7800	9300	8800	10500	75	140	
	40	700	7100	8400	8900	10500	9400	11200	8900	10500	10000	11900	88	135	
	40	800	7800	9300	9800	11700	10400	12400	9800	11700	11000	13100	101	130	
	40	870	8300	9900	10400	12400	11100	13200	10400	12400	11700	14000	110	127	
	80	40	-	-	-	-	2800	3000	-	-	3000	3200	20	160	
	80	60	-	-	-	-	4100	4400	-	-	4400	4700	30.2	156	
	80	75	-	-	-	-	5000	5400	-	-	5400	5800	37.8	153	
	80	90	-	-	-	-	5900	6400	-	-	6300	6800	45.5	149	
	80	105	-	-	-	-	6700	7300	-	-	7200	7800	53.5	146	
	80	110	-	-	-	-	7000	7600	-	-	7500	8200	56	146	
	80	120	-	-	-	-	7500	8200	-	-	8000	8700	62	140	
	80	135	-	-	-	-	8300	9000	-	-	8900	9700	70	139	
	80	140	-	-	-	-	8500	9300	-	-	9100	9900	71	139	
	80	160	-	-	-	-	9400	10300	-	-	10100	11000	85	129	
	80	180	-	-	-	-	10200	11200	-	-	11000	12000	97	124	
80	200	-	-	-	-	11000	12000	-	-	11800	12800	109	117		

Tolerance on LED flux is ± 7% and on total luminaire power ± 5%



Luminaire	Number of LEDs	Current (mA)	Luminaire output flux (lm) Warm White 722		Luminaire output flux (lm) Warm White 727		Luminaire output flux (lm) Warm White 730		Luminaire output flux (lm) Warm White 830		Luminaire output flux (lm) Neutral White 740		Power consumption (W)	Luminaire efficacy (lm/W)	Up to	Photometry
			Min	Max	Min	Max	Min	Max	Min	Max	Min	Max				
IZYLUM 3	40	200	2400	2800	3000	3500	3200	3800	3000	3500	3400	4000	24.3	165	LENSO FLEX ⁴	
	40	300	3500	4100	4400	5100	4700	5400	4400	5100	4900	5700	37	154	LENSO FLEX ⁴	
	40	350	4000	4700	5000	5900	5400	6300	5000	5900	5700	6600	42.5	155	LENSO FLEX ⁴	
	40	400	4500	5300	5700	6600	6000	7000	5700	6600	6400	7400	49	151	LENSO FLEX ⁴	
	40	450	5000	5800	6300	7300	6700	7800	6300	7300	7000	8200	55	149	LENSO FLEX ⁴	
	40	500	5500	6400	6800	8000	7300	8500	6800	8000	7700	9000	61.5	146	LENSO FLEX ⁴	
	40	550	5900	6900	7400	8700	7900	9200	7400	8700	8300	9700	68	143	LENSO FLEX ⁴	
	40	600	6300	7400	8000	9300	8500	9900	8000	9300	9000	10400	75	139	LENSO FLEX ⁴	
	40	700	7200	8400	9000	10500	9600	11200	9000	10500	10100	11800	88	134	LENSO FLEX ⁴	
	50	200	3000	3500	3800	4400	4000	4700	3800	4400	4200	4900	29.8	164	LENSO FLEX ⁴	
	50	300	4400	5100	5500	6400	5900	6800	5500	6400	6200	7200	45	160	LENSO FLEX ⁴	
	50	350	5000	5800	6300	7300	6700	7800	6300	7300	7100	8200	52.5	156	LENSO FLEX ⁴	
	50	400	5600	6600	7100	8200	7500	8800	7100	8200	8000	9300	60.5	154	LENSO FLEX ⁴	
	50	450	6200	7300	7800	9100	8300	9700	7800	9100	8800	10200	68.5	149	LENSO FLEX ⁴	
	50	500	6800	7900	8500	9900	9100	10600	8500	9900	9600	11200	76	147	LENSO FLEX ⁴	
	50	550	7400	8600	9200	10700	9800	11400	9200	10700	10400	12100	83	146	LENSO FLEX ⁴	
	50	600	7900	9200	9900	11500	10500	12200	9900	11500	11100	12900	91	142	LENSO FLEX ⁴	
	50	700	8800	10300	11100	12900	11800	13700	11100	12900	12500	14500	107	136	LENSO FLEX ⁴	
	60	200	3600	4200	4500	5300	4800	5600	4500	5300	5100	5900	38	155	LENSO FLEX ⁴	
	60	300	5300	6100	6600	7700	7000	8200	6600	7700	7400	8600	55	156	LENSO FLEX ⁴	
	60	350	6000	7000	7600	8800	8100	9400	7600	8800	8500	9900	64.5	153	LENSO FLEX ⁴	
	60	400	6800	7900	8500	9900	9100	10500	8500	9900	9600	11100	74	150	LENSO FLEX ⁴	
	60	450	7500	8700	9400	10900	10000	11600	9400	10900	10600	12300	81	152	LENSO FLEX ⁴	
	60	500	8200	9500	10300	11900	10900	12700	10300	11900	11500	13400	90	149	LENSO FLEX ⁴	
	60	550	8800	10300	11100	12900	11800	13700	11100	12900	12500	14500	100	145	LENSO FLEX ⁴	
	60	600	9500	11000	11900	13800	12600	14700	11900	13800	13300	15500	109	142	LENSO FLEX ⁴	
	60	700	10600	12400	13300	15500	14200	16500	13300	15500	15000	17400	128	136	LENSO FLEX ⁴	
	70	200	4200	4900	5300	6100	5600	6500	5300	6100	5900	6900	41	168	LENSO FLEX ⁴	
	70	300	6200	7200	7700	9000	8200	9600	7700	9000	8700	10100	62.5	162	LENSO FLEX ⁴	
	70	350	7000	8200	8800	10300	9400	10900	8800	10300	9900	11600	73	159	LENSO FLEX ⁴	
70	400	7900	9200	9900	11500	10600	12300	9900	11500	11200	13000	83	157	LENSO FLEX ⁴		
70	450	8800	10200	11000	12800	11700	13600	11000	12800	12300	14400	94	153	LENSO FLEX ⁴		
70	500	9600	11100	12000	13900	12800	14800	12000	13900	13500	15700	105	150	LENSO FLEX ⁴		
70	550	10300	12000	12900	15000	13800	16000	12900	15000	14500	16900	116	146	LENSO FLEX ⁴		
70	600	11100	12900	13800	16100	14800	17200	13800	16100	15600	18100	127	143	LENSO FLEX ⁴		
70	670	12000	14000	15100	17500	16000	18600	15100	17500	16900	19700	142	139	LENSO FLEX ⁴		

	80	40	-	-	-	-	2800	3000	-	-	3000	3200	20	160	MID FLEX*2
	80	60	-	-	-	-	4200	4400	-	-	4500	4800	30.2	159	MID FLEX*2
	80	75	-	-	-	-	5100	5300	-	-	5400	5700	37.8	151	MID FLEX*2

Tolerance on LED flux is $\pm 7\%$ and on total luminaire power $\pm 5\%$



Luminaire	Number of LEDs	Current (mA)	Luminaire output flux (lm) Warm White 722		Luminaire output flux (lm) Warm White 727		Luminaire output flux (lm) Warm White 730		Luminaire output flux (lm) Warm White 830		Luminaire output flux (lm) Neutral White 740		Power consumption (W)	Luminaire efficacy (lm/W)	Up to	Photometry
			Min	Max	Min	Max	Min	Max	Min	Max	Min	Max				
IZYLUM 3	80	90	-	-	-	-	6000	6400	-	-	6400	6800	46	148	MID FLEX*2	
	80	105	-	-	-	-	6800	7300	-	-	7300	7800	54	144	MID FLEX*2	
	80	110	-	-	-	-	7100	7600	-	-	7600	8200	56.5	145	MID FLEX*2	
	80	120	-	-	-	-	7700	8200	-	-	8200	8800	62.5	141	MID FLEX*2	
	80	135	-	-	-	-	8500	9000	-	-	9100	9700	71	137	MID FLEX*2	
	80	140	-	-	-	-	8700	9300	-	-	9300	10000	74	135	MID FLEX*2	
	80	160	-	-	-	-	9700	10300	-	-	10400	11100	85	131	MID FLEX*2	
	80	162	-	-	-	-	10600	11300	-	-	11300	12100	86	141	MID FLEX*2	
	80	200	4800	5600	6000	7000	6400	7500	6000	7000	6800	7900	46.5	170	LENZO FLEX*4	
	80	300	7000	8200	8800	10300	9400	10900	8800	10300	9900	11500	70	164	LENZO FLEX*4	
	80	350	8100	9400	10100	11800	10800	12500	10100	11800	11400	13200	82	161	LENZO FLEX*4	
	80	400	9100	10500	11400	13200	12100	14100	11400	13200	12800	14900	95	157	LENZO FLEX*4	
	80	450	10000	11600	12500	14600	13400	15500	12500	14600	14100	16400	107	153	LENZO FLEX*4	
	80	500	10900	12700	13700	15900	14600	17000	13700	15900	15400	17900	119	150	LENZO FLEX*4	
	80	550	11800	13700	14800	17200	15800	18300	14800	17200	16600	19300	132	146	LENZO FLEX*4	
	80	600	12600	14700	15800	18400	16800	19600	15800	18400	17800	20600	144	143	LENZO FLEX*4	
	80	670	13700	16000	17200	20000	18300	21300	17200	20000	19400	22500	162	139	LENZO FLEX*4	
	120	40	-	-	-	-	4200	4500	-	-	4500	4800	28.9	166	MID FLEX*2	
	120	60	-	-	-	-	6200	6600	-	-	6700	7100	43.5	163	MID FLEX*2	
	120	75	-	-	-	-	7600	8100	-	-	8200	8700	55	158	MID FLEX*2	
	120	90	-	-	-	-	9000	9600	-	-	9600	10200	67	152	MID FLEX*2	
	120	105	-	-	-	-	10300	10900	-	-	11000	11700	78	150	MID FLEX*2	
	120	110	-	-	-	-	10700	11400	-	-	11500	12200	82	149	MID FLEX*2	
	120	120	-	-	-	-	11500	12200	-	-	12300	13100	90	146	MID FLEX*2	
	120	135	-	-	-	-	12700	13300	-	-	13600	14200	103	138	MID FLEX*2	
	120	140	-	-	-	-	13100	13900	-	-	14000	14900	107	139	MID FLEX*2	
	120	162	-	-	-	-	14700	15600	-	-	15700	16700	127	131	MID FLEX*2	
	160	40	-	-	-	-	5700	6000	-	-	6100	6500	38	171	MID FLEX*2	
	160	60	-	-	-	-	8300	8900	-	-	9000	9500	57	167	MID FLEX*2	
	160	75	-	-	-	-	10200	10800	-	-	10900	11600	72	161	MID FLEX*2	
	160	90	-	-	-	-	12000	12800	-	-	12900	13700	88	156	MID FLEX*2	
	160	105	-	-	-	-	13700	14600	-	-	14700	15700	103	152	MID FLEX*2	
	160	110	-	-	-	-	14300	15200	-	-	15300	16300	109	150	MID FLEX*2	
160	120	-	-	-	-	15400	16300	-	-	16500	17500	119	147	MID FLEX*2		
160	135	-	-	-	-	16900	18000	-	-	18200	19300	136	142	MID FLEX*2		
160	140	-	-	-	-	17400	18600	-	-	18700	19900	141	141	MID FLEX*2		

	160	162	-	-	-	-	19600	20800	-	-	21000	22300	167	134	
--	-----	-----	---	---	---	---	-------	-------	---	---	-------	-------	-----	-----	---

























Tolerance on LED flux is $\pm 7\%$ and on total luminaire power $\pm 5\%$



Luminaire	Number of LEDs	Current (mA)	Luminaire output flux (lm) Warm White 722		Luminaire output flux (lm) Warm White 727		Luminaire output flux (lm) Warm White 730		Luminaire output flux (lm) Warm White 830		Luminaire output flux (lm) Neutral White 740		Power consumption (W)	Luminaire efficacy (lm/W)	Photometry
			Min	Max	Min	Max	Min	Max	Min	Max	Min	Max			
IZYLUM 4	70	200	4300	4900	5400	6100	5700	6500	5400	6100	6000	6900	41	168	
	70	300	6200	7100	7700	8800	8200	9400	7700	8800	8700	9900	62.5	158	
	70	350	7100	8100	8900	10100	9400	10800	8900	10100	10000	11400	73	156	
	70	400	7900	9100	9900	11300	10600	12100	9900	11300	11200	12800	83	154	
	70	450	8700	10000	10900	12500	11700	13300	10900	12500	12300	14100	94	150	
	70	500	9500	10900	11900	13600	12700	14500	11900	13600	13400	15300	105	146	
	70	550	10200	11700	12800	14600	13700	15600	12800	14600	14400	16500	116	142	
	70	600	10900	12500	13700	15600	14600	16600	13700	15600	15400	17600	127	139	
	80	200	4900	5600	6100	7000	6500	7500	6100	7000	6900	7900	46.5	170	
	80	300	7100	8100	8900	10100	9400	10800	8900	10100	10000	11400	70	163	
	80	350	8100	9200	10100	11600	10800	12300	10100	11600	11400	13000	82	159	
	80	400	9100	10400	11400	13000	12100	13800	11400	13000	12800	14600	95	154	
	80	450	10000	11400	12500	14300	13300	15200	12500	14300	14100	16100	107	150	
	80	500	10900	12400	13600	15600	14500	16600	13600	15600	15300	17500	119	147	
	80	550	11700	13400	14700	16700	15600	17800	14700	16700	16500	18800	132	142	
	80	600	12500	14300	15600	17900	16700	19000	15600	17900	17600	20100	144	140	
	100	200	6100	7000	7700	8800	8200	9300	7700	8800	8600	9900	62	171	
	100	300	8800	10100	11100	12700	11800	13500	11100	12700	12500	14200	92	161	
	100	350	10100	11600	12700	14500	13500	15400	12700	14500	14300	16300	107	158	
	100	400	11300	13000	14200	16200	15100	17300	14200	16200	16000	18300	122	155	
	100	450	12500	14300	15700	17900	16700	19100	15700	17900	17600	20100	137	150	
	100	500	13600	15500	17000	19500	18100	20700	17000	19500	19200	21900	152	147	
	100	550	14600	16700	18300	20900	19500	22300	18300	20900	20600	23500	170	138	
	100	600	15600	17800	19600	22300	20800	23800	19600	22300	22000	25100	186	135	
120	200	7400	8400	9200	10500	9800	11200	9200	10500	10400	11900	71	168		
120	300	10600	12100	13300	15200	14200	16200	13300	15200	15000	17100	107	160		

Tolerance on LED flux is ± 7% and on total luminaire power ± 5 %



Luminaire	Number of LEDs	Current (mA)	Luminaire output flux (lm) Warm White 722		Luminaire output flux (lm) Warm White 727		Luminaire output flux (lm) Warm White 730		Luminaire output flux (lm) Warm White 830		Luminaire output flux (lm) Neutral White 740		Power consumption (W)	Luminaire efficacy (lm/W)	Up to	Photometry
			Min	Max	Min	Max	Min	Max	Min	Max	Min	Max				
IZYLUM 4	120	350	12200	13900	15200	17400	16200	18500	15200	17400	17100	19600	126	156		
	120	400	13600	15600	17100	19500	18200	20800	17100	19500	19200	21900	144	152		
	120	450	15000	17100	18800	21500	20000	22900	18800	21500	21100	24100	162	149		
	120	500	16300	18600	20500	23400	21800	24900	20500	23400	23000	26300	180	146		
	120	550	17600	20100	22000	25100	23400	26800	22000	25100	24800	28300	200	142		
	120	600	18800	21400	23500	26800	25000	28600	23500	26800	26400	30200	218	139		
	160	40	-	-	-	-	5700	6000	-	-	6200	6400	38	168		
	160	60	-	-	-	-	8500	8900	-	-	9100	9500	57	167		
	160	80	-	-	-	-	10900	11300	-	-	11600	12200	77	158		
	160	100	-	-	-	-	13100	13700	-	-	14100	14700	98	150		
	160	120	-	-	-	-	15200	15900	-	-	16300	17000	119	143		
	160	140	-	-	-	-	17000	17800	-	-	18200	19000	141	135		
	200	40	-	-	-	-	7200	7500	-	-	7700	8000	47	170		
	200	60	-	-	-	-	10500	11000	-	-	11300	11800	71	166		
	200	80	-	-	-	-	13600	14200	-	-	14600	15200	96	158		
	200	100	-	-	-	-	16400	17200	-	-	17600	18400	122	151		
	200	120	-	-	-	-	19000	19800	-	-	20400	21300	149	143		
	200	132	-	-	-	-	20400	21300	-	-	21900	22900	165	139		
	240	40	-	-	-	-	8600	9000	-	-	9200	9700	58	167		
	240	60	-	-	-	-	12600	13200	-	-	13500	14200	87	163		
240	80	-	-	-	-	16300	17100	-	-	17500	18300	118	155			
240	100	-	-	-	-	19700	20600	-	-	21100	22100	150	147			
240	120	-	-	-	-	22800	23800	-	-	24400	25500	180	142			
240	140	-	-	-	-	25500	26700	-	-	27400	28600	214	134			

Tolerance on LED flux is ± 7% and on total luminaire power ± 5 %



Luminaire	Number of LEDs	Current (mA)	Luminaire output flux (lm) Warm White 722		Luminaire output flux (lm) Warm White 727		Luminaire output flux (lm) Warm White 730		Luminaire output flux (lm) Warm White 830		Luminaire output flux (lm) Neutral White 740		Power consumption (W)	Luminaire efficacy (lm/W)	Up to	Photometry
			Min	Max	Min	Max	Min	Max	Min	Max	Min	Max				
IZYLUM 5	70	200	4300	4900	5400	6200	5800	6600	5400	6200	6100	6900	41	168	LENSO FLEX ⁴	
	70	300	6300	7200	7900	9000	8400	9600	7900	9000	8900	10200	62.5	163	LENSO FLEX ⁴	
	70	350	7200	8200	9000	10300	9600	10900	9000	10300	10100	11500	73	158	LENSO FLEX ⁴	
	70	400	8000	9100	10000	11400	10700	12200	10000	11400	11300	12900	83	155	LENSO FLEX ⁴	
	70	450	8800	10100	11000	12600	11800	13400	11000	12600	12400	14200	94	151	LENSO FLEX ⁴	
	70	500	9600	10900	12000	13700	12800	14600	12000	13700	13500	15400	105	147	LENSO FLEX ⁴	
	70	550	10400	11900	13000	14900	13900	15800	13000	14900	14600	16700	116	144	LENSO FLEX ⁴	
	70	600	11200	12800	14000	16000	15000	17100	14000	16000	15800	18000	127	142	LENSO FLEX ⁴	
	70	700	12600	14400	15800	18000	16800	19200	15800	18000	17800	20300	149	136	LENSO FLEX ⁴	
	70	750	12900	14700	16200	18500	17200	19700	16200	18500	18200	20800	162	128	LENSO FLEX ⁴	
	80	200	4900	5600	6200	7100	6600	7500	6200	7100	7000	7900	46.5	170	LENSO FLEX ⁴	
	80	300	7200	8200	9000	10300	9600	11000	9000	10300	10200	11600	70	166	LENSO FLEX ⁴	
	80	350	8200	9400	10300	11700	10900	12500	10300	11700	11600	13200	82	161	LENSO FLEX ⁴	
	80	400	9100	10400	11500	13100	12200	13900	11500	13100	12900	14700	95	155	LENSO FLEX ⁴	
	80	450	10100	11500	12600	14400	13500	15400	12600	14400	14200	16200	107	151	LENSO FLEX ⁴	
	80	500	10900	12500	13700	15700	14600	16700	13700	15700	15400	17600	119	148	LENSO FLEX ⁴	
	80	550	11900	13600	14900	17000	15900	18100	14900	17000	16700	19100	132	145	LENSO FLEX ⁴	
	80	600	12800	14600	16100	18300	17100	19500	16100	18300	18100	20600	144	143	LENSO FLEX ⁴	
	80	700	14400	16500	18100	20600	19300	22000	18100	20600	20300	23200	176	132	LENSO FLEX ⁴	
	80	750	14800	16800	18500	21100	19700	22500	18500	21100	20800	23700	188	126	LENSO FLEX ⁴	
	100	200	6200	7100	7700	8800	8300	9400	7700	8800	8700	9900	62	171	LENSO FLEX ⁴	
	100	300	9000	10300	11300	12900	12100	13800	11300	12900	12700	14500	92	165	LENSO FLEX ⁴	
	100	350	10300	11700	12900	14700	13700	15600	12900	14700	14500	16500	107	160	LENSO FLEX ⁴	
	100	400	11400	13100	14300	16400	15300	17400	14300	16400	16100	18400	122	156	LENSO FLEX ⁴	
	100	450	12600	14400	15800	18000	16800	19200	15800	18000	17800	20300	137	151	LENSO FLEX ⁴	
	100	500	13700	15600	17200	19600	18300	20900	17200	19600	19300	22000	152	148	LENSO FLEX ⁴	
	100	550	14900	17000	18600	21300	19800	22600	18600	21300	20900	23900	170	141	LENSO FLEX ⁴	
	100	600	16000	18300	20100	22900	21400	24400	20100	22900	22600	25800	186	139	LENSO FLEX ⁴	
	100	700	18100	20600	22600	25800	24100	27500	22600	25800	25400	29000	218	133	LENSO FLEX ⁴	
	100	750	18500	21100	23100	26400	24600	28100	23100	26400	26000	29700	234	127	LENSO FLEX ⁴	
120	200	7400	8500	9300	10600	9900	11300	9300	10600	10500	11900	71	168	LENSO FLEX ⁴		

Tolerance on LED flux is ± 7% and on total luminaire power ± 5 %



Luminaire	Number of LEDs	Current (mA)	Luminaire output flux (lm) Warm White 722		Luminaire output flux (lm) Warm White 727		Luminaire output flux (lm) Warm White 730		Luminaire output flux (lm) Warm White 830		Luminaire output flux (lm) Neutral White 740		Power consumption (W)	Luminaire efficacy (lm/W)	Up to	Photometry
			Min	Max	Min	Max	Min	Max	Min	Max	Min	Max				
IZYLUM 5	120	300	10800	12400	13600	15500	14500	16500	13600	15500	15300	17500	107	164		LENZO FLEX*4
	120	350	12300	14100	15400	17600	16400	18800	15400	17600	17400	19800	126	157		LENZO FLEX*4
	120	400	13700	15700	17200	19600	18300	20900	17200	19600	19300	22100	144	153		LENZO FLEX*4
	120	450	15100	17300	19000	21600	20200	23100	19000	21600	21300	24300	162	150		LENZO FLEX*4
	120	500	16400	18800	20600	23500	21900	25000	20600	23500	23200	26400	180	147		LENZO FLEX*4
	120	550	17900	20400	22400	25500	23800	27200	22400	25500	25100	28700	200	144		LENZO FLEX*4
	120	600	19200	22000	24100	27500	25700	29300	24100	27500	27100	30900	218	142		LENZO FLEX*4
	120	700	21700	24700	27100	31000	28900	33000	27100	31000	30500	34800	256	136		LENZO FLEX*4
	120	750	22200	25300	27800	31700	29600	33700	27800	31700	31200	35600	280	127		LENZO FLEX*4
	160	40	-	-	-	-	5700	6000	-	-	6200	6400	38	168		MID FLEX*2
	160	60	-	-	-	-	8400	8700	-	-	9000	9400	57	165		MID FLEX*2
	160	80	-	-	-	-	10900	11400	-	-	11700	12200	77	158		MID FLEX*2
	160	100	-	-	-	-	13300	13800	-	-	14200	14800	98	151		MID FLEX*2
	160	120	-	-	-	-	15500	16100	-	-	16600	17200	119	145		MID FLEX*2
	160	140	-	-	-	-	17400	18100	-	-	18700	19400	141	138		MID FLEX*2
	160	160	-	-	-	-	19200	19900	-	-	20600	21400	165	130		MID FLEX*2
	160	170	-	-	-	-	20000	20800	-	-	21500	22300	182	123		MID FLEX*2
	200	40	-	-	-	-	7200	7500	-	-	7700	8000	47	170		MID FLEX*2
	200	60	-	-	-	-	10500	10900	-	-	11300	11700	71	165		MID FLEX*2
	200	80	-	-	-	-	13700	14200	-	-	14700	15200	96	158		MID FLEX*2
	200	100	-	-	-	-	16600	17200	-	-	17800	18500	122	152		MID FLEX*2
	200	120	-	-	-	-	19300	20100	-	-	20700	21500	149	144		MID FLEX*2
	200	132	-	-	-	-	20800	21600	-	-	22300	23200	165	141		MID FLEX*2
	240	40	-	-	-	-	8600	9000	-	-	9300	9600	58	166		MID FLEX*2
	240	60	-	-	-	-	12600	13100	-	-	13500	14100	87	162		MID FLEX*2
	240	80	-	-	-	-	16400	17100	-	-	17600	18300	118	155		MID FLEX*2
	240	100	-	-	-	-	20000	20700	-	-	21400	22200	150	148		MID FLEX*2
	240	120	-	-	-	-	23200	24100	-	-	24900	25800	180	143		MID FLEX*2
	240	140	-	-	-	-	26100	27200	-	-	28000	29100	214	136		MID FLEX*2
	240	170	-	-	-	-	30100	31200	-	-	32200	33500	268	125		MID FLEX*2

Tolerance on LED flux is ± 7% and on total luminaire power ± 5 %

