



Anna System

LED

Anna System is greater than the sum of its parts. High-end design, control and optical features enable creating high quality lighting in demanding public spaces.

Optics

Ensto luminaires include variable possibilities for optical solutions to choose from. Symmetric, wide and many others, our product families have several options for light distribution and -output to fit your project and demand.

SmartWay

Ensto SmartWay is a self-learning, wirelessly networked and future proof control system. SmartWay luminaires listen and learn by themselves and from each other to make sure that there is always light on your way. Plug'n play, no programming or commissioning needed.

Tunable White

Ensto luminaires with Tunable White -solution are a base for Human Centric lighting. You can integrate Ensto TW -luminaires into numerous control systems which operate steplessly between 2700 K and 6500 K. Tunable White -solution is perfect for modern office use.

Dimming

Ensto can provide many dimming possibilities for luminaires. 1-10V, Switch Dim, DALI and base light are just few examples of possibilities to change the light output to fit your premises.

DALI

DALI drivers enable luminaires to be connected to DALI based control systems and Smart Buildings. Compared to a fixed output installation, the dimming and individual control capability provided by DALI enables considerable energy savings and control, depending on luminaire specifications.

"Anna System is greater than the sum of its parts."





Mounting options

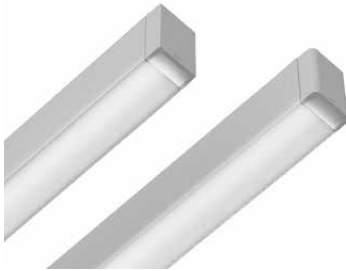

End cap square and round design



Anna microprism corner luminaire

Structure

- › Body white powder coated (RAL 9016) structure painted aluminium profile
- › End caps and corner modules structure painted aluminium
- › Low luminance aluminium louvre
- › Microprismatic optics polycarbonate
- › UGR<19
- › Models:
 - Direct light models for surface and wire suspension mounting
 - Uplight models (U), uplight 40%
 - Flush mount models (F)
- › 90° corner luminaires with microprismatic optics (ANL60M)
- › Square (S) or rounded (R) end caps
- › IP20
- › Connected load and luminous flux, see table
- › LED-module lifespan 100 000h (L70), T_a = 25 °C

Mounting

- › Wire suspension. Freely adjustable suspension points.
- › Surface mounting
- › Recessed mounting
- › Continuous light-line by connecting several luminaires
- › 90° corner module for connecting louvre versions
- › End caps to be ordered separately
- › Mounting accessories to be ordered separately

Made to order

- › 3000K models/3K
- › Tunable white models /TW
- › SmartWay self learning sensor /AA. Availability per model to be checked from Ensto Lighting product management
- › 50/50 light distribution
- › Project specific luminous flux packages 1500-4000 lm (direct light/uplight)

E number	Type	Product name	Luminous flux	Optics	Control
Anna System linear luminaires, suspended / surface mount					
42 603 75	ANS12L	ANS12L LED 21W/840 L	2400 lm	louvre	
42 604 60	ANS12LED	ANS12LED LED 21W/840 L DA	2400 lm	louvre	DALI
42 603 85	ANS15L	ANS15L LED 26W/840 L	3000 lm	louvre	
42 604 71	ANS15LED	ANS15LED LED 26W/840 L DA	3000 lm	louvre	DALI
42 603 81	ANS12M	ANS12M LED 15W/840 M	1550 lm	microprism	
42 604 66	ANS12MED	ANS12MED LED 15W/840 M DA	1550 lm	microprism	DALI
42 603 90	ANS15M	ANS15M LED 19W/840 M	1950 lm	microprism	
42 604 75	ANS15MED	ANS15MED LED 19W/840 M DA	1950 lm	microprism	DALI
42 603 68	ANL60M	ANL60M LED 15W/840 M	1550 lm	microprism, corner luminaire	
42 604 51	ANL60MED	ANL60MED LED 15W/840 M DA	1550 lm	microprism, corner luminaire	DALI
Anna System linear luminaires with uplight					
42 603 80	ANS12LU	ANS12LU LED 30W/840 L	3800 lm	louvre	
42 604 65	ANS12LUED	ANS12LUED LED 30W/840 L DA	3800 lm	louvre	DALI
42 603 87	ANS15LU	ANS15LU LED 38W/840 L	4700 lm	louvre	
42 604 73	ANS15LUED	ANS15LUED LED 38W/840 L DA	4700 lm	louvre	DALI
42 603 83	ANS12MU	ANS12MU LED 22W/840 M	2500 lm	microprism	
42 604 69	ANS12MUED	ANS12MUED LED 22W/840 M DA	2500 lm	microprism	DALI
42 603 92	ANS15MU	ANS15MU LED 27W/840 M	3100 lm	microprism	
42 604 78	ANS15MUED	ANS15MUED LED 27W/840 M DA	3100 lm	microprism	DALI
42 603 70	ANL60MU	ANL60MU LED 22W/840 M	2500 lm	microprism, corner luminaire	
42 604 57	ANL60MUED	ANL60MUED LED 22W/840 M DA	2500 lm	microprism, corner luminaire	DALI



E number	Type	Product name	Luminous flux	Optics	Control
Anna System linear luminaires, flush mount					
42 603 76	ANS12LF	ANS12LF LED 21W/840 L	2400 lm	louvre	
42 604 63	ANS12LFED	ANS12LFED LED 21W/840 L DA	2400 lm	louvre	DALI
42 603 86	ANS15LF	ANS15LF LED 26W/840 L	3000 lm	louvre	
42 604 72	ANS15LFED	ANS15LFED LED 26W/840 L DA	3000 lm	louvre	DALI
42 603 82	ANS12MF	ANS12MF LED 15W/840 M	1550 lm	microprism	
42 604 67	ANS12MFED	ANS12MFED LED 15W/840 M DA	1550 lm	microprism	DALI
42 603 91	ANS15MF	ANS15MF LED 19W/840 M	1950 lm	microprism	
42 604 77	ANS15MFED	ANS15MFED LED 19W/840 M DA	1950 lm	microprism	DALI
42 603 69	ANL60MF	ANL60MF LED 15W/840 M	1550 lm	microprism, corner luminaire	
42 604 54	ANL60MFED	ANL60MFED LED 15W/840 M DA	1550 lm	microprism, corner luminaire	DALI
Anna System accessories					
42 603 94	ANSE	ANSE end cap pair, square			
42 603 73	ANRE	ANRE end cap pair, round			
42 603 66	ANFSE	ANFSE end cap pair square, flush mount			
42 603 63	ANFRE	ANFRE end cap pair round, flush mount			
42 603 72	ANLR	ANLR 90° corner module for louvre			
42 603 71	ANLFR	ANLFR 90° corner module for louvre, flush mount			
42 660 60	RVLX01	RVLX01 WIRE SUSP.SET 1.5M	susp. wire set 1,5 m with friction locks		
42 660 61	RVLX02	RVLX02 WIRE SUSP.SET 1.5M Ø31	susp. wire set 1,5 m with friction locks, small ceiling cup ø 31 mm		
42 660 62	RVLX03	RVLX03 WIRE SUSP.SET 1.5M Ø67	susp. wire set 1,5 m with friction locks, large ceiling cup ø 67 mm		
42 661 08	RVLXT25	RVLXT25 WIRE SUSP.SET T-FRAME	susp. wire set with friction locks for T-frame		

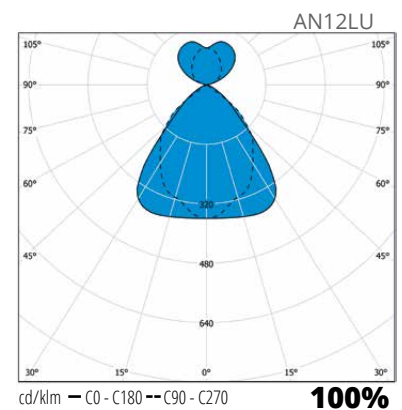
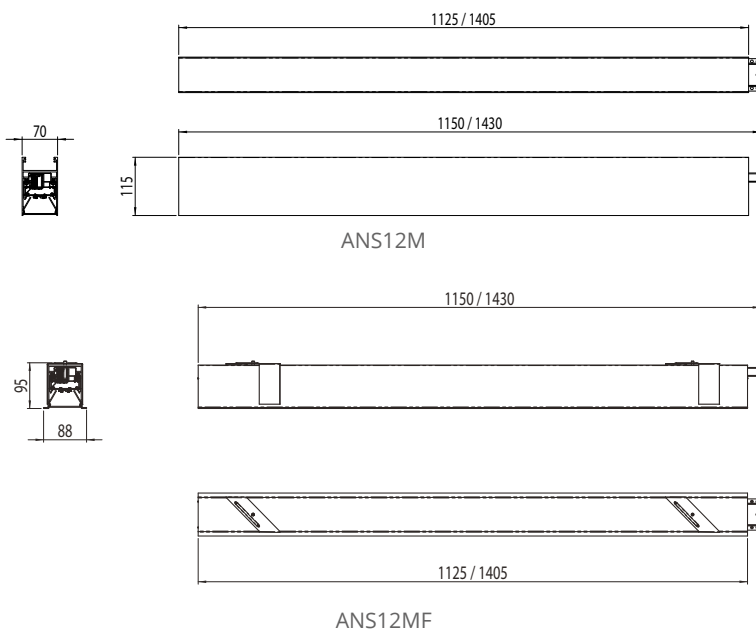
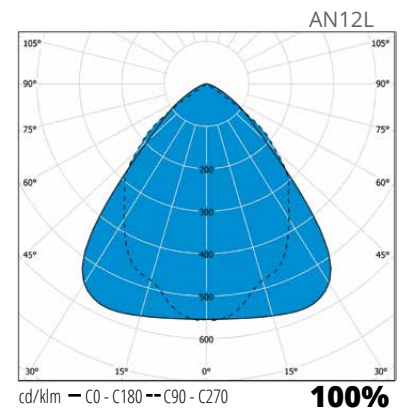
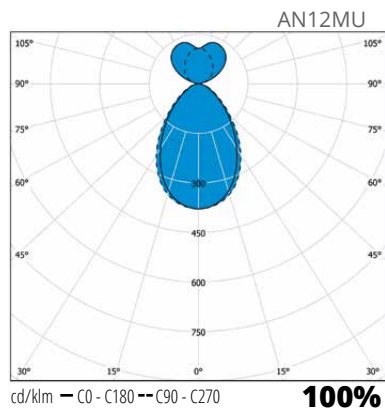
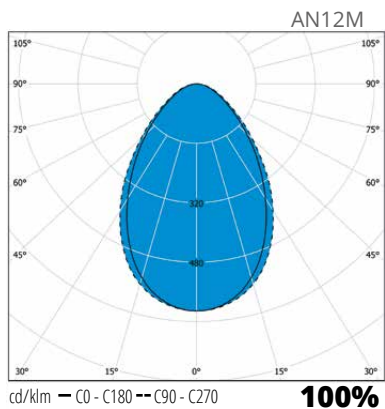

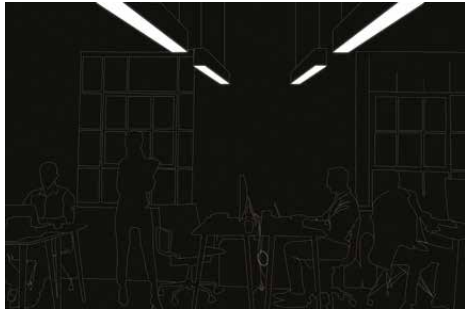
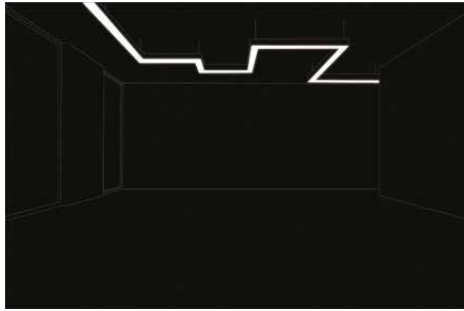
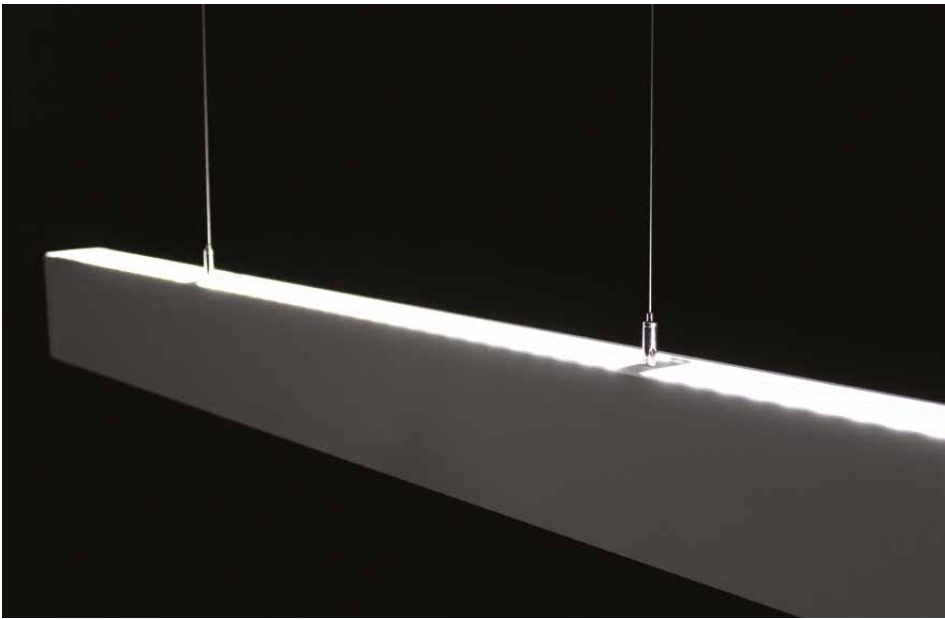

Create your own space.

System light-line installation with microprismatic optics.

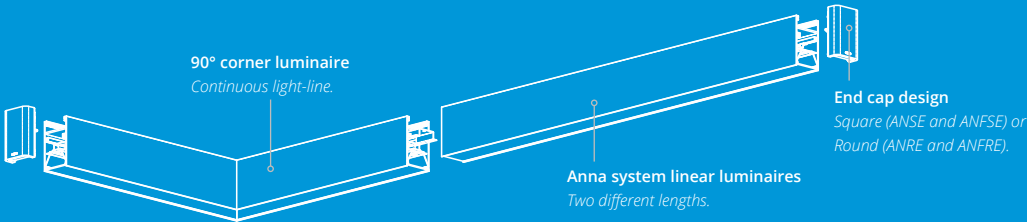

Anna System installation with low glare louvre.

