



# WORKSHOP SPECIFICATIONS



DISTRIBUTION  
ENCLOSURES

**XL<sup>3</sup> S 630**

# LEGRAND SUPPORTS YOU ON ALL YOUR PROJECTS

XL<sup>3</sup> S 630, is designed for home, commercial buildings. This enclosures range is dedicated to flow markets , standard projects and especially for panel builders.

A wide selection was engineered for your needs: 11 different heights, available in four widths corresponding to 16, 24 and 36 modules and external cable sleeves. Fixing accessories for protection devices, doors and panels are delivered separately.

Thanks to a wide variety of accessories, multiple mounting possibilities exist for all dimensions.

With the help of vertical and horizontal adapted busbar systems, XL<sup>3</sup> S 630 was designed to facilitate wiring and connection installation.

## LEGAL INFORMATION

Presentation pictures do not always include Personal Protective Equipment (PPE), but this is a legal and regulatory obligation that must be scrupulously respected.

In accordance with its continuous improvement policy, Legrand reserves the right to change the specifications and illustrations without notice. All illustrations, descriptions and technical information included in this document are provided as indications and cannot be held against Legrand.

---

# Content

XL <sup>3</sup> S 630 presentation	4
Enclosure assembly	10
Device mounting	18
Equipment mounting	26
Distribution system	38
Installation and finishing	48
Other accessories	54
Enclosures shipping and handling	56
Wall and/or floor fixing	58
Spare parts & accessories	60

DISTRIBUTION ENCLOSURES XL<sup>3</sup> S 630

# SAFETY INSTRUCTIONS



Any failure to strictly apply the procedures and to respect these recommendations, could lead to serious risk of accident, endangering people and property (in particular, without limitation, risk of burns, electric shocks, etc.)

## General information

- Use only the products and accessories recommended by the Legrand Group in the catalogue, instructions, technical data sheets and all other documents provided by Legrand (hereinafter referred to as "the Documentation") in compliance with the installation rules.



**Improper installation and/or use may result in the risk of arcing in the enclosure, overheating or fire. The enclosures must be used under normal conditions, they must not be subjected to Voltage / Current / Temperature values other than those specified in the Documentation.**

- Legrand declines all responsibility for any modification or repair of the equipment making up the enclosure that is not authorized by the Legrand Group, as well as any failure to comply with the rules and recommendations specified by Legrand in the Documentation. In addition, in the cases mentioned above, the warranty granted by Legrand will not be applicable.
- It is necessary to check that the characteristics of the products are appropriate for their environment and use during maintenance operations, and to refer to the Documentation.
- If you have any questions or require clarification, please contact Legrand Group.

## Protection/security



- The installation, use and maintenance of the enclosures and their components must be carried out by qualified, trained and authorized personnel, in accordance with the regulations in force in each country.
- People working on the installation must have the appropriate electrical authorizations for the work to be carried out.
- Wear the PPE (Personal Protective Equipment) necessary to work on live products.



- Respect the safety rules related to electrical work.
- Improper electrical and mechanical use of equipment can be dangerous and may result in personal injury or damage to property.

## Maintenance

- Depending on the maintenance operations to be carried out, partial or total power cuts of the enclosure concerned should be planned before any work.
- When performing operations that involve access to the inside of the enclosure, be aware of the risk of burns before touching any products and metallic parts.
- Before turning the power back on, make sure that there are no foreign bodies and that all physical protections have been put back in place (e.g.: screens, covers, faceplates).



**Risk of electric shock, burns and explosion.**

The rules and recommendations in this document are based on our knowledge of the typical conditions of use of our products in the fields of application usually encountered. However, it is always the customer's responsibility to verify and validate that Legrand products are suitable for its installation and use.

The customer must ensure proper installation, maintenance and operation of the equipment to avoid any risk of injury to personnel or damage to property in the event of product failure, especially for applications that require a very high level of safety (e.g., those in which the failure of a component may endanger human life or health).

The rules for storage, handling, installation and maintenance and the appropriate precautions and warnings must be strictly observed and applied.

# DISTRIBUTION ENCLOSURE XL<sup>3</sup> S 630 RANGE



## PRESENTATION

XL<sup>3</sup> S 630 enclosures enable to achieve your projects suitable to your environments.

XL<sup>3</sup> S 630 is composed of cabinets and enclosures available in 11 heights (multiples of 150mm), in four different widths 16, 24, 36 modules and cable ducts available in 11 plastronable heights, each in multiples of 150mm.

## CHARACTERISTICS

- Class I metallic cabinet.
- Short-circuits resistance:
  - l<sub>pk</sub>: 76,6kA.
  - l<sub>cc</sub>: 36kA.
- IP 30 without door, IP 40 door, IP 43 with a special kit.
- IK 07 without door, IK 08 with door.
- Conform to IEC 61439-2 standard.
- Can accept devices up to 630A.
- Colors:
  - Body RAL 7016.
  - Faceplates and doors RAL 9003.
- Rated insulation voltage (U<sub>i</sub>): 690V.
- Rated impulse - withstand voltage (U<sub>imp</sub>): 6kV.
- Temperature range: -5°C to +40°C.
- Storage temperature: -10°C to +70°C.
- Sheet thickness: 1,5mm.
- Panel and door thickness: 1,5mm.
- Thickness of structure upright: 2mm.

## i

Possibility to choose a special colour from a panel of 197 shades: RAL only possible on metal parts.

For any request about technical possibilities and extra costs, please contact your Legrand representative.

Supplied with 2 plates,  
top and bottom cable entry.

Supplied with  
2 functional  
uprights.

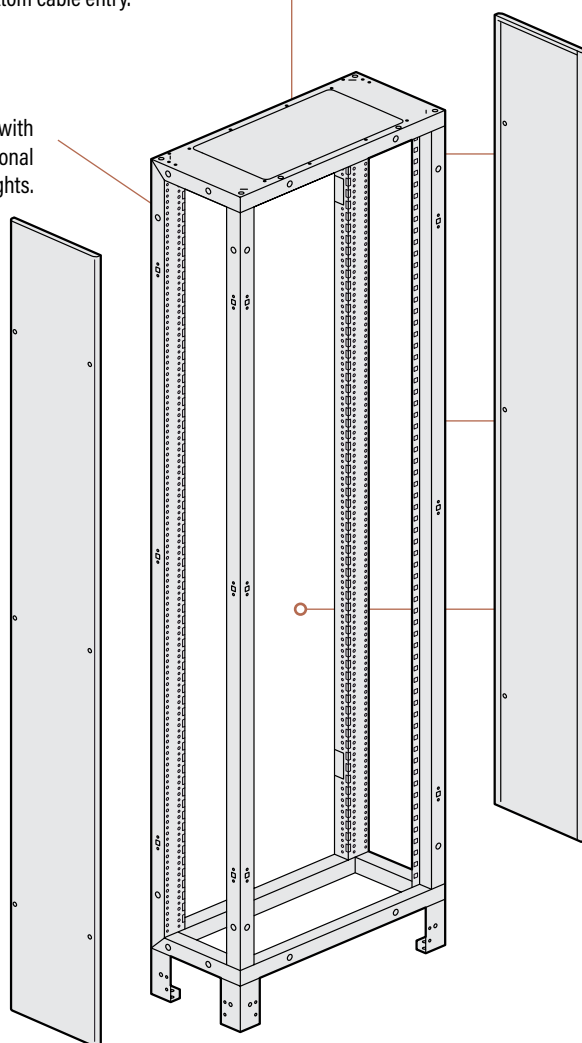

Delivered for assembly.

Supplied with 2 removable structures.

2 door finishes:  
- metal;  
- glass.  
Possibility of mounting an IP 30 finishing kit.

Fixing from the inside or outside of  
the enclosure.

# DISTRIBUTION ENCLOSURE XL<sup>3</sup> S 630 RANGE



## PRESENTATION

### DISTRIBUTION ENCLOSURE XL<sup>3</sup> S 630 RANGE

16 MODULES											
Plastronable height	H 750	H 900	H 1050	H 1200	H 1350	H 1500	H1650	H 1800	H 1950	H 2100	H 2250
Enclosures	3 375 21	3 375 31	3 375 41	3 375 51	3 375 61	3 375 71	3 375 81	3 375 91	3 376 01	3 376 11	3 376 21
Metal door	3 376 41	3 376 51	3 376 61	3 376 71	3 376 81	3 376 91	3 377 01	3 377 11	3 377 21	3 377 31	3 377 41
Glass door	3 377 51	3 377 61	3 377 71	3 377 81	3 377 91	3 378 01	3 378 11	3 378 21	3 378 31	3 378 41	3 378 51
Side panels	3 378 62	3 378 63	3 378 64	3 378 65	3 378 66	3 378 67	3 378 68	3 378 69	3 378 70	3 378 71	3 378 72
Finishing kit	3 379 72 + 3 379 60	3 379 72 + 3 379 61	3 379 72 + 3 379 62	3 379 72 + 3 379 63	3 379 72 + 3 379 64	3 379 72 + 3 379 65	3 379 72 + 3 379 66	3 379 72 + 3 379 67	3 379 72 + 3 379 68	3 379 72 + 3 379 69	3 379 72 + 3 379 70

24 MODULES											
Plastronable height	H 750	H 900	H 1050	H 1200	H 1350	H 1500	H1650	H 1800	H 1950	H 2100	H 2250
Enclosures	3 375 22	3 375 32	3 375 42	3 375 52	3 375 62	3 375 72	3 375 82	3 375 92	3 376 02	3 376 12	3 376 22
Metal door	3 376 42	3 376 52	3 376 62	3 376 72	3 376 82	3 376 92	3 377 02	3 377 12	3 377 22	3 377 32	3 377 42
Glass door	3 377 52	3 377 62	3 377 72	3 377 82	3 377 92	3 378 02	3 378 12	3 378 22	3 378 32	3 378 42	3 378 52
Side panels	3 378 62	3 378 63	3 378 64	3 378 65	3 378 66	3 378 67	3 378 68	3 378 69	3 378 70	3 378 71	3 378 72
Finishing kit	3 379 73 + 3 379 60	3 379 73 + 3 379 61	3 379 73 + 3 379 62	3 379 73 + 3 379 63	3 379 73 + 3 379 64	3 379 73 + 3 379 65	3 379 73 + 3 379 66	3 379 73 + 3 379 67	3 379 73 + 3 379 68	3 379 73 + 3 379 69	3 379 73 + 3 379 70



36 MODULES											
Plastronable height	H 750	H 900	H 1050	H 1200	H 1350	H 1500	H 1650	H 1800	H 1950	H 2100	H 2250
Enclosures	3 375 23	3 375 33	3 375 43	3 375 53	3 375 63	3 375 73	3 375 83	3 375 93	3 376 03	3 376 13	3 376 23
Metal door	3 376 43	3 376 53	3 376 63	3 376 73	3 376 83	3 376 93	3 377 03	3 377 13	3 377 23	3 377 33	3 377 43
Glass door	3 377 53	3 377 63	3 377 73	3 377 83	3 377 93	3 378 03	3 378 13	3 378 23	3 378 33	3 378 43	3 378 53
Side panels	3 378 62	3 378 63	3 378 64	3 378 65	3 378 66	3 378 67	3 378 68	3 378 69	3 378 70	3 378 71	3 378 72
Finishing kit	3 379 74 + 3 379 60	3 379 74 + 3 379 61	3 379 74 + 3 379 62	3 379 74 + 3 379 63	3 379 74 + 3 379 64	3 379 74 + 3 379 65	3 379 74 + 3 379 66	3 379 74 + 3 379 67	3 379 74 + 3 379 68	3 379 74 + 3 379 69	3 379 74 + 3 379 70
Internal cable sleeve kit	3 379 32	3 379 33	3 379 34	3 379 35	3 379 36	3 379 37	3 379 38	3 379 39	3 379 40	3 379 41	3 379 42
Internal CS faceplates	3 379 12	3 379 13	3 379 14	3 379 15	3 379 16	3 379 17	3 379 18	3 379 19	3 379 20	3 379 21	3 379 22

EXTERNAL CABLE SLEEVES											
Plastronable height	H 750	H 900	H 1050	H 1200	H 1350	H 1500	H 1650	H 1800	H 1950	H 2100	H 2250
Enclosures	3 375 20	3 375 30	3 375 40	3 375 50	3 375 60	3 375 70	3 375 80	3 375 90	3 376 00	3 376 10	3 376 20
Metal door	3 376 40	3 376 50	3 376 60	3 376 70	3 376 80	3 376 90	3 377 00	3 377 10	3 377 20	3 377 30	3 377 40
Finishing kit	3 379 71 + 3 379 60	3 379 71 + 3 379 61	3 379 71 + 3 379 62	3 379 71 + 3 379 63	3 379 71 + 3 379 64	3 379 71 + 3 379 65	3 379 71 + 3 379 66	3 379 71 + 3 379 67	3 379 71 + 3 379 68	3 379 71 + 3 379 69	3 379 71 + 3 379 70
Faceplates	3 378 82	3 378 84	3 378 86	3 378 88	3 378 90	3 378 92	3 378 94	3 378 96	3 378 98	3 379 00	3 379 02
Functional uprights	3 379 86	3 379 87	3 379 88	3 379 89	3 379 90	3 379 91	3 379 92	3 379 93	3 379 94	3 379 95	3 379 96

# DISTRIBUTION ENCLOSURE XL<sup>3</sup> S 630 RANGE



## PRESENTATION

## Dimensions

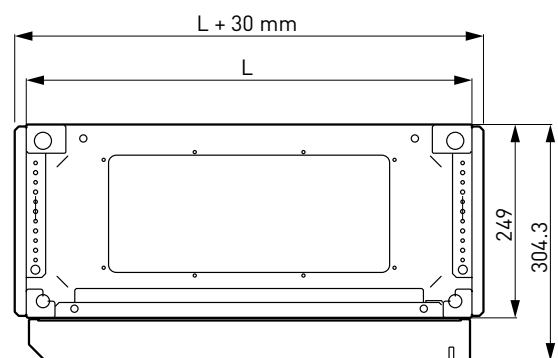
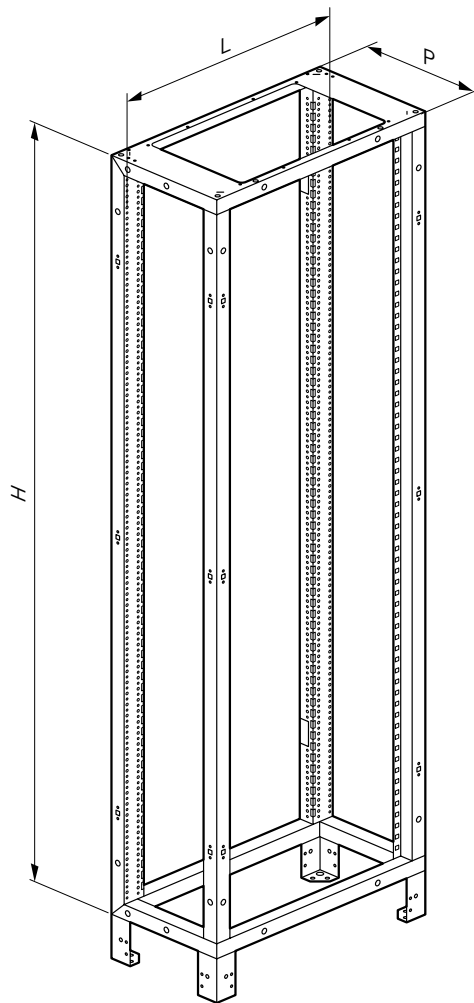

**16 MODULES ENCLOSURES (external dimensions)**

Cat.Nos	L (mm)	H (mm)	P (mm)
3 375 21	424	824	249
3 375 31	424	974	249
3 375 41	424	1124	249
3 375 51	424	1274	249
3 375 61	424	1424	249
3 375 71	424	1574	249
3 375 81	424	1724	249
3 375 91	424	1874	249
3 376 01	424	2024	249
3 376 11	424	2174	249
3 376 21	424	2324	249

**24 MODULES ENCLOSURES (external dimensions)**

Cat.Nos	L (mm)	H (mm)	P (mm)
3 375 22	574	824	249
3 375 32	574	974	249
3 375 42	574	1124	249
3 375 52	574	1274	249
3 375 62	574	1424	249
3 375 72	574	1574	249
3 375 82	574	1724	249
3 375 92	574	1874	249
3 376 02	574	2024	249
3 376 12	574	2174	249
3 376 22	574	2324	249

**36 MODULES ENCLOSURES (external dimensions)**

Cat.Nos	L (mm)	H (mm)	P (mm)
3 375 23	774	824	249
3 375 33	774	974	249
3 375 43	774	1124	249
3 375 53	774	1274	249
3 375 63	774	1424	249
3 375 73	774	1574	249
3 375 83	774	1724	249
3 375 93	774	1874	249
3 376 03	774	2024	249
3 376 13	774	2174	249
3 376 23	774	2324	249

**EXTERNAL CABLE SLEEVES (external dimensions)**

Cat.Nos	L (mm)	H (mm)	P (mm)
3 375 20	324	824	249
3 375 30	324	974	249
3 375 40	324	1124	249
3 375 50	324	1274	249
3 375 60	324	1424	249
3 375 70	324	1574	249
3 375 80	324	1724	249
3 375 90	324	1874	249
3 376 00	324	2024	249
3 376 10	324	2174	249
3 376 20	324	2324	249

## ENCLOSURE ASSEMBLY

The enclosures are equipped with:

- 2 functional uprights;
- 2 removable structure uprights;
- 2 fixing supports for faceplates (delivered assembled);
- 2 plates for cable entries (high and low) supplied with their screws.

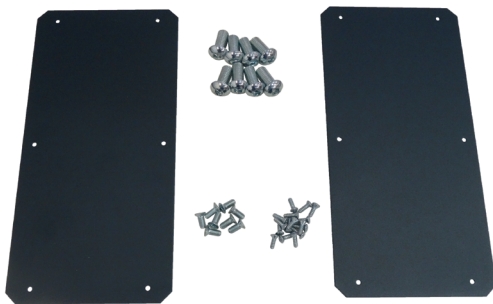

The enclosure has a sense of implementation (Top/ Bottom). The part opening on the right (quantity→ 4), as shown below, represents the bottom part of your enclosure. These holes are required in case of an angle base installation.

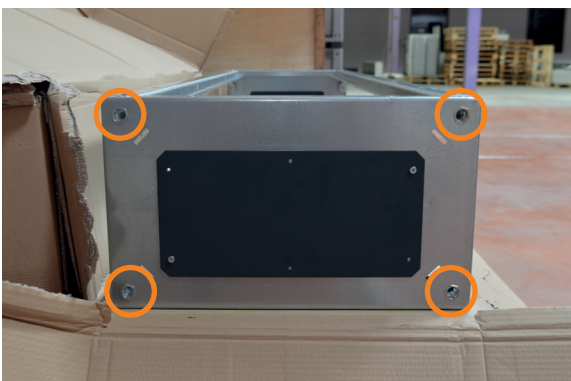

## Plates for cable entry assembly

The plates are fixed on the outside of the enclosure except in case of floor-flush mounting. In this case, the lower plate is fixed on the inside of the enclosure.

1. Place the plate(s) on the upper or lower part of your enclosure.
2. Fix the plate(s) using the screws supplied (big screw thread) → Philips n°1, tightening torque 5 N.m.

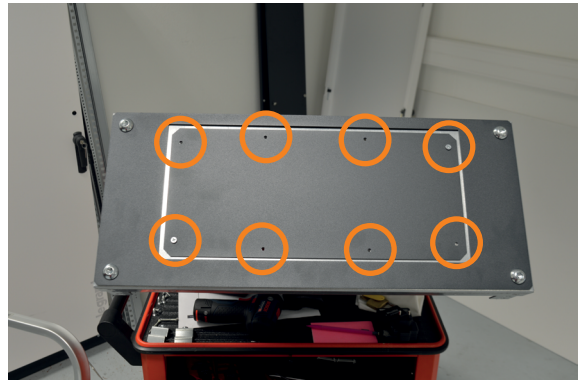

## Bases assembly (Cat.No 3 382 00)



To facilitate the good position of cables, bases are stackable.

From 1574mm height (1500mm usable height) we recommend using bases.

You can stack two bases without attaching the enclosure to a wall. When stacking 3 or 4 bases, you must attach the enclosure to a wall (more details in the chapter "Installing enclosures").



4 bases are the maximum allowable.

3. Fix the bracket(s) onto your enclosure while engaging the tab. Then, insert the screw and tighten (8mm hex key), tightening torque 8 N.m.

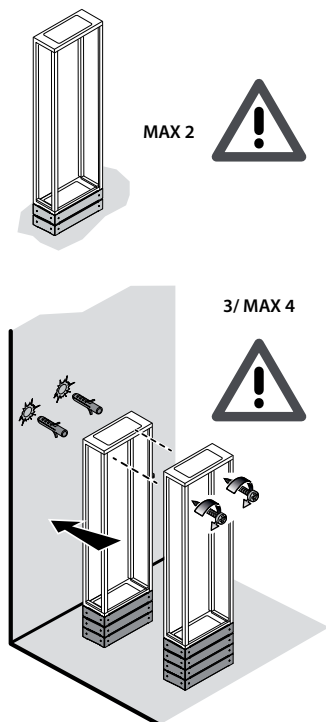

Regarding the floor-mounted option, more details are available in the chapter "Enclosures installation"

## Finishing panels for bases assembly

The catalogue number includes: 4 corner pieces, 4 screws, 4 washers, and 4 nuts.

Regarding ground bases, the fixing screws are not provided.

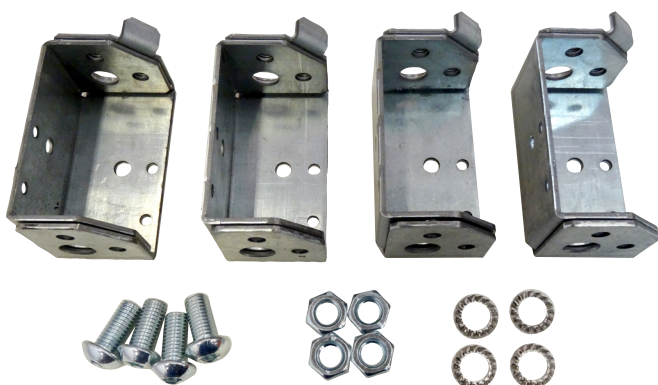

**i** When superposing several bases, you need to complete the angles coupling first.

The catalogue number includes: 2 plates and 4 fixing screws. There are 5 different length available :

- 3 382 01 → front/rear panels external cable sleeve;
- 3 382 02 → front/rear panels for 16 modules enclosure;
- 3 382 03 → front/rear panels for 24 modules enclosure;
- 3 382 04 → front/rear panels for 36 modules enclosure;
- 3 382 05 → left/right side all enclosures + external cable sleeve.



1. Position the covering between two angles.
2. Fix the two retainer screws: Torx key Size 30, tightening torque 5 N.m.

To install the bases you must first:

1. Remove the 4 screws that hold the large plate with an 8mm hex key.
2. Insert the screw provided (8mm) in the two brackets, then the washer and finish with the nut, flat-wrench (19mm), tightening torque 15 N.m.

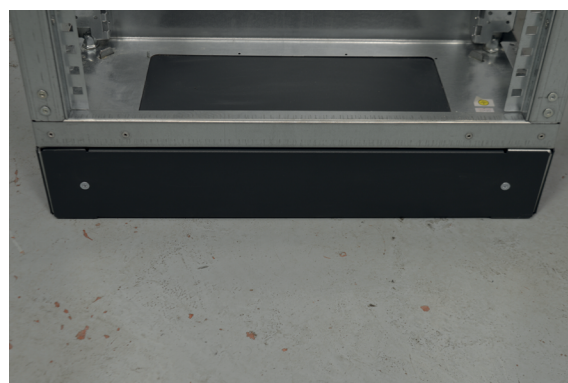
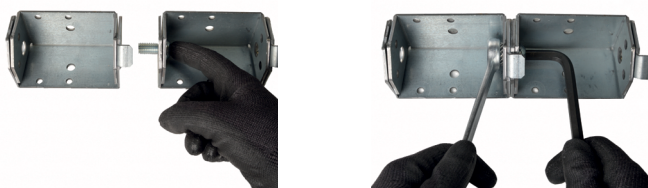

## ENCLOSURE ASSEMBLY

### Side panels mounting (check the Cat.Nos in the chapter page 6)



For all your enclosures mountings, make sure to use the largest holes to fix the equipment. Smaller holes must be used for inserting anti-rotation stud.

The catalogue number includes 2 panels with their accessories: screws, washers, cage-nuts, and retaining brackets with their screws.



1. Place the retaining bracket on the upper side rail of your enclosure (approximately in the middle) with the screw provided, → Torx key S30, tightening torque 8 N.m.

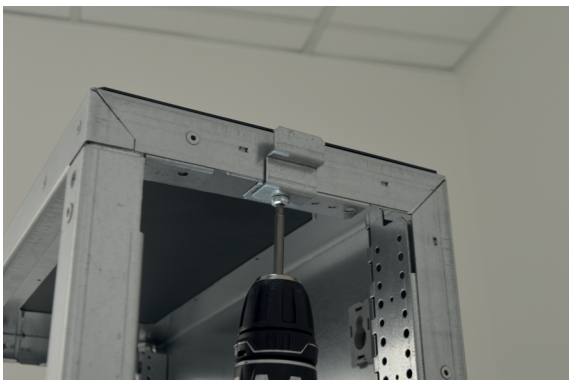

2. Position the cage-nuts in the holes provided in the casing and engage them with a mallet.



3. Insert screws and washers in the side panels



4. Attach the panel on the retaining bracket, then fix it by turning the screws 1/4 turn to the right.

## Enclosure coupling

- IP 43 seal (Cat.No 3 379 51)

It is possible to obtain the IP 43 by sticking the seal on the inner edge of the side panels, passageway plates, the door and between the enclosures if joined together. It is self-adhesive.

Thickness	Width	Length
2mm	10mm	10 m

Installation of the door seal:

- Hinges and closing points on the structure side.

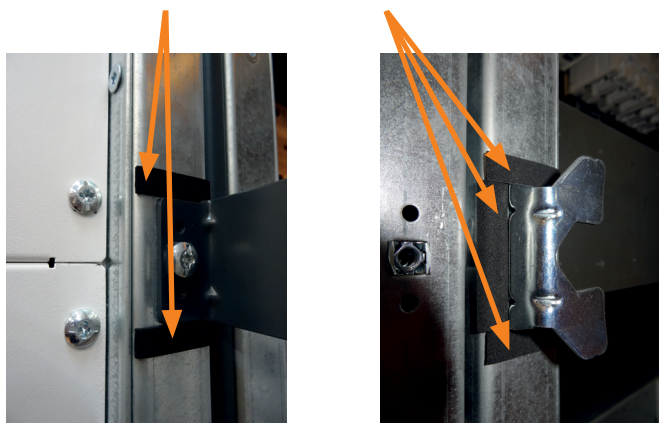

- Inner corner of the door (double the seal at the top and bottom)



- Passing through door openings



- Coupling with the kits Cat.Nos 3 379 50 and 3 379 49

Two coupling kits exist: 1 basic kit (screws and nuts Cat.No 3 379 50) and 1 reinforced with plates (Cat.No 3 379 49), recommended for the shipping.

### COUPLING WITH THE KIT CAT.NO 3 379 50

This kit includes 8 screws, 2 nuts and 6 cage-nuts.



1. Position the cage-nuts on the side of one of the 2 enclosures, in the holes expected for his purpose.



## ENCLOSURE ASSEMBLY

2. Gather the enclosures, while checking the absence of base panels on the side of your two enclosures.  
Position the screws in the holes non-equipped with cage-nuts and tighten, hexagonal head 10mm, tightening torque 8 N.m.

Passageway screws holes – front/rear panels:



3. Remove the 2 bases panels before taking off the 2 enclosures.  
Position one screw (max. 2 screws if 2 bases are stacked) and one nut in the middle of the rear base(s) → flat key 10mm, tightening torque 8 N.m.



### COUPLING WITH THE KIT CAT.NO 3 379 49

This kit includes 6 self-tapping screws, 3 flat plates and 1 angle bracket.

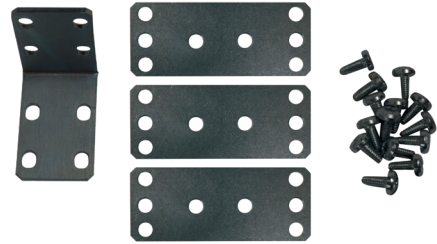

For all your enclosures mountings, make sure to use the largest holes to fix the equipment. Smaller holes are usually used for inserting anti-rotation stud.

The angle bracket needs to be positioned in the upper angle on the front of your enclosure.

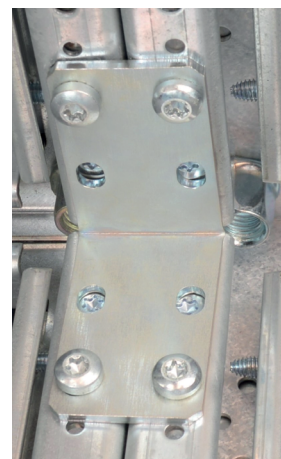



The 3 flat plates need to be positioned like so: 1 on the upper back of your enclosure, 1 on the lower back and 1 on the lower behind the front uprights.

Example of a front upright in position:

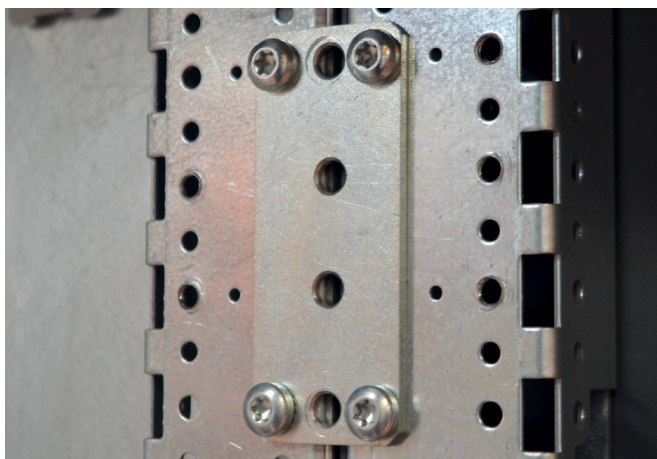

To fix your screws, use a Torx key S30, tightening torque 8 N.m.

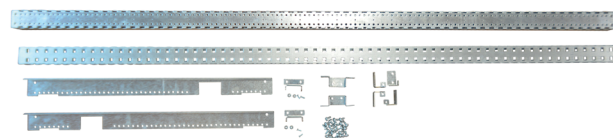

1. Fix the first bracket of the top crossbar using 2 screws → Torx key S30, tightening torque 5 N.m.

The top screw should be positioned in the second hole of the upright from the top.

## Internal cable sleeve kit



For all your enclosures mountings, make sure to use the largest holes to fix the equipment. Smaller holes are for inserting anti-rotation stud.

The XL<sup>3</sup> S 630 enclosures with a width of 36 modules can be equipped with an internal cable sleeve. It can be installed on the right or left with a transfer busbar at the top or bottom.



Identify the need before starting the assembly.

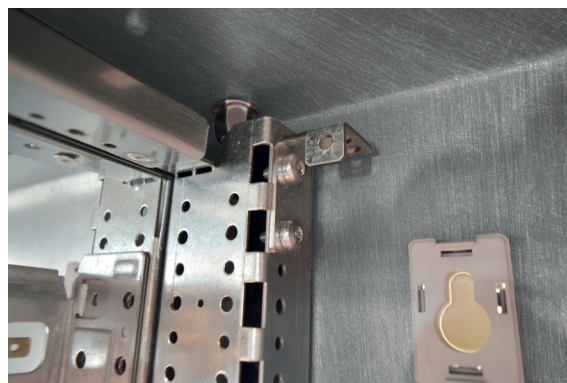

2. Fix the bottom screw of the second bracket (without tightening it) in the fourth hole (from the top) of the upright.



## ENCLOSURE ASSEMBLY

3. Position the crossbar (pay attention to the orientation according to the configuration), rotate the free bracket and insert the second screw.
4. Tighten both screws → Torx key S30, tightening torque 5 N.m.

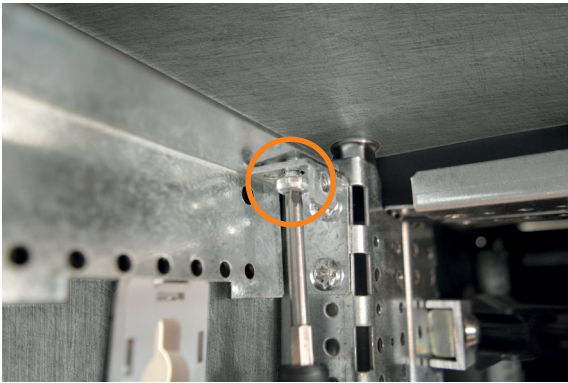

5. Install the top support bracket of the internal cable sleeve upright, the brackets of the bottom crossbar, the bottom support bracket of the internal cable sleeve upright, and finally the complete crossbar on the brackets.



All screws must be tightened to a torque of 5 N.m using a Torx key S30.



1. Insert the internal cable sleeve upright into the 2 support brackets and fix it using the 4 screws → Torx key S30, tightening torque 5 N.m.



2. Remove the top and bottom rubber caps at the location of the internal cable sleeve faceplates support.



3. Place the nut clips on the two brackets with square holes then fix them to the structure of the enclosure: countersunk head screw → Philips n°2, tightening torque 5 N.m.



4. Fix the support faceplates with the 4 screws → Torx key S30, tightening torque 5 N.m.



If needed, refer to chapters about the assembly of the faceplates and the potential equipotential bonding.

**i**

There are 11 faceplates Cat.Nos for cable sleeves (for 11 heights). These Cat.Nos (see page 7) is composed of:

- 1 faceplate from 750mm to 1200mm height.
- 2 faceplates from 1350mm to 2250mm height.

**!**

Pour tous les montages dans les enveloppes, veiller à toujours utiliser les plus gros trous pour la fixation des équipements. Les petits trous servent à l'insertion de plots anti-rotation.

**+**

For mounting the enclosures to the wall and/or the floor ► see page 60.  
For the transport and handling of the enclosures ► see page 58.

## DEVICE MOUNTING

### Volumes: the principle of the definition

Each device after being fixing on a bar or a plate, has its own faceplate. The height defines the volume needed for the installation, connection, insulating distances as well as the heat dissipation optimal conditions. Once positioned, the faceplates guarantee the IP30 degree of protection.

Different heights are available:

- From 150mm to 600mm for safety and power outage devices.
- From 50mm to 600mm for plain faceplates (exclusive of cable sleeves). They enable the equipment of the needed zones regarding the cable passage, busbars installation and specific equipment implementation.



**For all mounting in enclosures, always use the largest holes to fix the equipment. The smaller holes are for the insertion of anti-rotation studs.**

**When installing and wiring the equipment, it is necessary to place the enclosure on a wider support so that the products are flat. For ease of assembly, it is recommended to first remove the front structural uprights (4 screws per upright, 2 at the top and 2 at the bottom), attach the products to the plates, and then assemble the whole unit into the enclosure.**

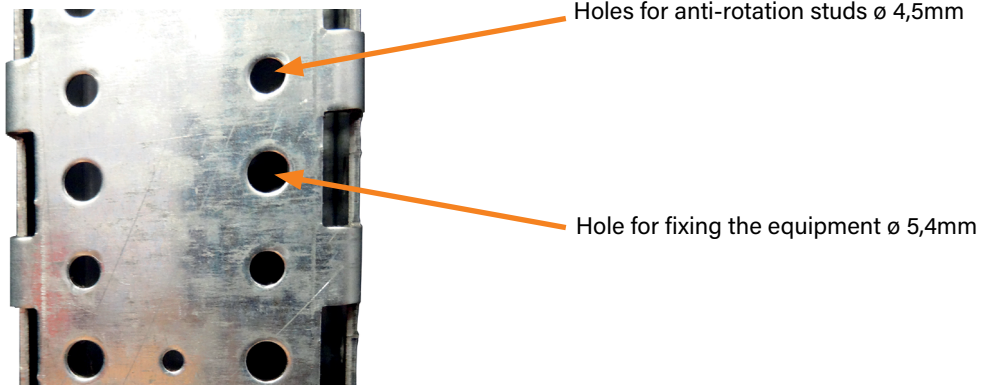

Example of removing an upright in a corner:

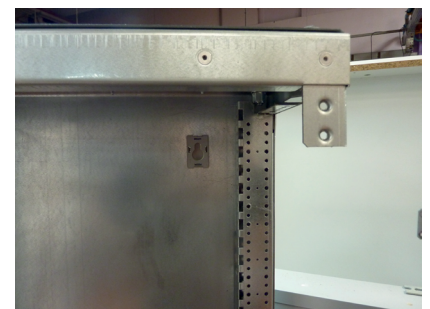

DEVICES	ENCLOSURE	POSITION	CONFIGURATION	FIXING ACCESSORIES			FACEPLATES HEIGHTS (MM)	
				RAIL	PLATE	BRACKETS		
Modular devices	Width 16 mod.	Vertical	-	3 382 20 3 382 21	-	-	150	3 382 51
	Width 24 mod.			3 382 23 3 382 24				3 382 52
	Width 36 mod.			3 382 26 3 382 27				3 382 53
DRX 125	Width 16 mod.	Vertical	1 pole	3 382 20 + 0 271 89	-	-	300	3 382 71
	Width 24 mod.		2 poles	3 382 23 + 0 271 90				3 382 72
	Width 36 mod.		3P/4P	3 382 26 + 0 271 87				3 382 73
DRX 125 HP	Width 16 mod.	Horizontal	3P	-	-	-	100	3 383 50
	Width 16 mod.		4P				3 383 51	
	Width 24 mod.		3P				3 383 53	
	Width 24 mod.		4P				3 383 54	
	Width 36 mod.		3P				3 383 56	
	Width 36 mod.	4P	3 383 57					
	Width 16 mod.	Vertical	3P/4P	3 385 21	-	-	250	3 382 61
	Width 24 mod.		3P	3 385 23				3 382 62
	Width 24 mod.		4P	3 385 24				3 382 62
	Width 36 mod.		3P	3 385 26				3 382 63
Width 36 mod.	4P		3 385 27	3 382 63				
DPX <sup>3</sup> 125 HP	Width 16 mod.	Horizontal	3P	-	-	-	100	3 385 50
	Width 16 mod.		4P				3 385 51	
	Width 24 mod.		3P				3 385 53	
	Width 24 mod.		4P				3 385 54	
	Width 36 mod.		3P				3 385 56	
	Width 36 mod.	4P	3 385 57					
	Width 16 mod.	Vertical	3P/4P	3 385 21	-	-	250	3 385 71
	Width 24 mod.		3P	3 385 23				3 385 73
	Width 24 mod.		4P	3 385 24				3 385 74
	Width 36 mod.		3P	3 385 26				3 385 76
Width 36 mod.	4P		3 385 27	3 385 77				
DPX <sup>3</sup> 160	Width 16 mod.	Horizontal/ side uprights	3P	-	-	-	150	3 383 00
			4P with or without earth leakage					3 383 01
	Width 24 mod.		3P					3 383 04
			4P with or without earth leakage					3 383 04
	Width 36 mod.		3P					3 383 07
		4P with or without earth leakage	3 383 07					
	Width 16 mod.	Horizontal/ central uprights	3P	-	-	-	100	3 396 20
			4P with or without earth leakage					3 396 10
	Width 24 mod.		3P					3 396 20
			4P with or without earth leakage					3 396 10
	Width 36 mod.		3P					3 396 20
		4P with or without earth leakage	3 396 10					
	Width 16 mod.	Vertical	3P ou 4P	-	-	-	300	3 383 20
			4P with earth leakage					3 383 21
Width 24 mod.	3P		3 383 23					
	4P		3 383 24					
Width 36 mod.	4P with earth leakage		3 383 25					
	3P		3 383 26					
	4P		3 383 27					
			4P with earth leakage				3 383 28	

## DEVICE MOUNTING

DEVICES	ENCLOSURE	POSITION	CONFIGURATION	FIXING ACCESSORIES			FACEPLATES HEIGHTS (MM)		
				RAIL	PLATE	BRACKETS			
DPX <sup>3</sup> 160 (continued)	Width 16 mod.	Vertical	No side motor drive	3 382 20 + 4 210 71	-	-	300	3 382 71	
			With earth leakage module - no side motor drive	3 382 20 + 4 210 73					
			With side motor drive	3 382 20 + 4 210 68					
	Width 24 mod.		Without side motor drive	3 382 23 + 4 210 71					
			With earth leakage module - no side motor drive	3 382 23 + 4 210 73					
			With side motor drive	3 382 23 + 4 210 68					
	Width 36 mod.		Without side motor drive	3 382 26 + 4 210 71					
			With earth leakage module - no side motor drive	3 382 26 + 4 210 73					
			With side motor drive	3 382 26 + 4 210 68					
	Width 16 mod.	Vertical	With earth leakage module - no side motor drive	3 382 26 + 4 210 73	3 383 80	-	300	3 383 83	
			With side motor drive	3 382 26 + 4 210 68	3 383 81			3 383 84	
			3P/4P with rotary handle	-	3 383 82			3 383 85	
DRX 250	Width 16 mod.	Vertical	All types	3 382 20 + 0 271 88	-	-	300	3 382 71	
	Width 24 mod.			3 382 23 + 0 271 88				3 382 72	
	Width 36 mod.			3 382 26 + 0 271 88				3 382 73	
DRX 250 HP	Width 16 mod.	Horizontal	3P	-	-	-	150	3 384 50	
			4P with or without earth leakage				3 386 01 <sup>(1)</sup> / 3 396 24 <sup>(2)</sup>	200	3 384 51
	Width 24 mod.		3P				3 386 04 <sup>(1)</sup> / 3 396 24 <sup>(2)</sup>	150	3 384 53
			4P with or without earth leakage				3 386 04 <sup>(1)</sup> / 3 396 16 <sup>(2)</sup>	200	3 384 54
	Width 36 mod.		3P				3 386 07 <sup>(1)</sup> / 3 396 24 <sup>(2)</sup>	150	3 384 56
			4P with or without earth leakage				3 386 07 <sup>(1)</sup> / 3 396 16 <sup>(2)</sup>	200	3 384 57
	Width 16 mod.	Vertical	3P	-	-	-	300	3 382 71	
			4P with or without earth leakage					3 386 21	3 382 72
	Width 24 mod.		3P					3 386 23	
			4P with or without earth leakage					3 386 24	
	Width 36 mod.		3P					3 386 26	3 382 73
			4P with or without earth leakage					3 386 27	

<sup>(1)</sup>: On side uprights

<sup>(2)</sup>: On central uprights

DEVICES	ENCLOSURE	POSITION	CONFIGURATION	FIXING ACCESSORIES			FACEPLATES HEIGHTS (MM)		
				RAIL	PLATE	BRACKETS			
DPX <sup>3</sup> 250 HP	Width 16 mod.	Horizontal	3P	-	-	-	150	3 386 01 <sup>(1)</sup> / 3 396 24 <sup>(2)</sup>	
			4P with or without earth leakage					3 386 01 <sup>(1)</sup> / 3 396 16 <sup>(2)</sup>	
	3P		3 386 04 <sup>(1)</sup> / 3 396 24 <sup>(2)</sup>				150	3 386 53	
	4P with or without earth leakage		3 386 04 <sup>(1)</sup> / 3 396 16 <sup>(2)</sup>					200	3 386 54
	Width 36 mod.		3P				3 386 07 <sup>(1)</sup> / 3 396 24 <sup>(2)</sup>	150	3 386 56
			4P with or without earth leakage				3 386 07 <sup>(1)</sup> / 3 396 16 <sup>(2)</sup>		200
	Width 16 mod.	Vertical	3P	-	-	-	300	3 386 20	
			4P with or without earth leakage					3 386 21	
			3P					3 386 23	
			4P with or without earth leakage					3 386 24	
			Width 36 mod.					3P	3 386 26
								4P with or without earth leakage	3 386 27
DPX-IS 250	Width 24 mod.	Horizontal	3P/4P	-	-	300	3 389 02		
	Width 36 mod.						3 389 04		
	Width 16 mod.	Vertical	3P/4P	-	-	300	3 389 20		
	Width 24 mod.						3 389 22		
	Width 36 mod.						3 389 24		

<sup>(1)</sup>: On side uprights

<sup>(2)</sup>: On central uprights

## DEVICE MOUNTING

DEVICES	ENCLOSURE	POSITION	CONFIGURATION	FIXING ACCESSORIES			FACEPLATES HEIGHTS (MM)	
				RAIL	PLATE	BRACKETS		
DPX <sup>3</sup> 250	Width 16 mod.	Horizontal/ side uprights	3P	-	3 384 01	-	150	3 384 50
			3P or 4P with or without earth leakage				200	3 384 51
	3P		150				3 384 53	
	3P or 4P with or without earth leakage		200				3 384 54	
	3P		150				3 384 56	
	3P or 4P with or without earth leakage		200				3 384 57	
	Width 24 mod.	Horizontal/ central uprights	3P	-	3 396 21	-	150	3 384 50
			4P with or without earth leakage				200	3 384 51
	3P		150				3 384 53	
	4P with or without earth leakage		200				3 384 54	
	3P		150				3 384 56	
	3P or 4P with or without earth leakage		200				3 384 57	
	Width 36 mod.	Vertical	3P/4P	-	3 384 20	-	300	3 382 71
			4P with earth leakage					
	3P		3 384 23					3 382 72
	4P		3 384 24					
	4P with earth leakage		3 384 25					
	3P		3 384 26					3 382 73
	4P	3 384 27						
	4P with earth leakage	3 384 28						
Width 16 mod.	Vertical	Without side motor drive	3 382 20 + 4 210 72	-	-	300	3 382 71	
		With earth leakage - without side motor drive	3 382 20 + 4 210 74					
With side motor drive		3 382 20 + 4 210 69						
With earth leakage and cover		3 382 20 + 4 210 74	400				3 382 81	



DEVICES	ENCLOSURE	POSITION	CONFIGURATION	FIXING ACCESSORIES			FACEPLATES HEIGHTS (MM)	
				RAIL	PLATE	BRACKETS		
DPX <sup>3</sup> 250 (continued)	Width 24 mod.	-	Without side motor drive	3 382 23 + 4 210 72	-	-	300	3 382 72
			With earth leakage - without side motor drive	3 382 23 + 4 210 74				
			With side motor drive	3 382 23 + 4 210 69				
			With earth leakage and cover	3 382 23 + 4 210 74			400	3 382 82
	Width 36 mod.	-	Without side motor drive	3 382 26 + 4 210 72	-	-	300	3 382 73
			With earth leakage - without side motor drive	3 382 26 + 4 210 74				
			With side motor drive	3 382 26 + 4 210 69				
			With earth leakage and cover	3 382 26 + 4 210 74			400	3 382 83
	Width 16 mod.	Vertical	3P/4P with rotary handle	-	3 383 95	-	300	3 383 83
	Width 24 mod.		3P/4P with rotary handle	-	3 383 96			3 383 84
	Width 36 mod.		3P/4P with rotary handle	-	3 383 97			3 383 85
	DPX-IS 630	Width 24 mod.	Horizontal/side uprights	3P/4P	-	3 390 02	300	3 390 41
Width 36 mod.		Horizontal/side uprights	3P/4P	-	3 390 14	3 390 43		
		Horizontal/ central uprights	3P	-	3 396 14			
Width 16 mod.		Vertical	3P/4P	-	3 390 20	-	400	3 390 50
Width 24 mod.			3P/4P		3 390 22		3 390 52	
Width 36 mod.			3P/4P		3 390 24		3 390 54	

## DEVICE MOUNTING

DEVICES	ENCLOSURE	POSITION	CONFIGURATION	FIXING ACCESSORIES			FACEPLATES HEIGHTS (MM)	
				RAIL	PLATE	BRACKETS		
DPX <sup>3</sup> 630	Width 16 mod.	Vertical	3P/4P with rotary handle	-	3 383 86	-	400	3 383 92
	Width 24 mod.		3P/4P with rotary handle		3 383 87			3 383 93
	Width 36 mod.		3P/4P with rotary handle		3 383 88			3 383 94
	Width 16 mod.		3P/4P with motor drive		3 383 89			3 383 92
	Width 24 mod.		3P/4P with motor drive		3 383 90			3 383 93
	Width 36 mod.		3P/4P with motor drive		3 383 91			3 383 94
	Width 16 mod.	Horizontal/side uprights	3P	-	3 387 01	-	200	3 387 51
			4P		3 387 04			3 387 54
	Width 24 mod.		3P		3 387 07			3 387 57
			4P					
	Width 36 mod.	Horizontal/central uprights	3P	-	3 396 22	-	150	3 387 50
	Width 16 mod.		4P with or without earth leakage		3 396 12		200	3 387 51
			3P		3 396 22		150	3 387 53
	Width 24 mod.		4P with or without earth leakage		3 396 12		200	3 387 54
			3P		3 396 22		150	3 387 56
	Width 36 mod.		4P without earth leakage		3 396 12		200	3 387 57
			4P with earth leakage		3 396 12		200	3 387 58
	Width 16 mod.	Vertical	3P/4P without earth leakage	-	3 387 20	-	400	3 387 70
			4P with earth leakage		3 387 21		600	3 387 71
	Width 24 mod.		3P/4P without earth leakage		3 387 24		400	3 387 74
			4P with earth leakage		3 387 25		600	3 387 75
	Width 36 mod.	Vertical	3P/4P without earth leakage	-	3 387 27	-	400	3 387 77
			4P with earth leakage		3 387 28		600	3 387 78

DEVICES	ENCLOSURE	POSITION	CONFIGURATION	FIXING ACCESSORIES			FACEPLATES HEIGHTS (MM)		
				RAIL	PLATE	BRACKETS			
SPX-D 50/100 A (NFC)	Width 24 mod.	Vertical	3P/4P	-	3 398 00	-	300	3 398 08	
	Width 36 mod.				3 398 01			3 398 09	
SPX-D 63/100 A (NH)	Width 24 mod.	Vertical	3P/4P	-	3 398 02	-	300	3 398 08	
	Width 36 mod.				3 398 03			3 398 09	
SPX-D 125/160 A (NH)	Width 24 mod.	Vertical	3P/4P	-	3 398 04	-	300	3 398 10	
	Width 36 mod.				3 398 05			3 398 11	
SPX-D 250 A (NH)	Width 24 mod.	Vertical	3P/4P	-	3 398 06	-	450	3 398 12	
	Width 36 mod.				3 398 07			3 398 13	
DSX SD	Width 16 mod.	Vertical	3P/4P frame 1	-	3 389 61	-	300	3 382 71	
			3P frame 2		3 389 66				
	Width 24 mod.		3P/4P frame 1		3 389 62			300	3 382 72
			3P/4P frame 2		3 389 67				
	Width 24 mod.	Horizontal	3P/4P frame 1	-	3 389 60	-	300	3 389 64	
			3P/4P frame 2		3 389 65			3 389 70	
	Width 36 mod.	Vertical	3P/4P frame 1	-	3 389 63	-	300	3 382 73	
			3P/4P frame 2		3 389 68				
DSX TSE	Width 16 mod.	Vertical	3P/4P frame 1	-	3 389 72	-	300	3 382 71	
			3P/4P frame 2		3 389 76				
	Width 24 mod.		3P/4P frame 1		3 389 73			300	3 382 72
			3P/4P frame 2		3 389 77				
	Width 24 mod.	Horizontal	3P/4P frame 1	-	3 389 71	-	300	3 389 64	
			3P/4P frame 2		3 389 75			3 389 70	
	Width 36 mod.	Vertical	3P/4P frame 1	-	3 389 74	-	300	3 382 73	
			3P/4P frame 2		3 389 78				

## EQUIPMENT MOUNTING

### Fixing systems mounting

There are 3 devices fixing systems:

- Plates: DRX, DPX IS 250/630, SPX-D, DSX and DPX<sup>3</sup> 160/250/630.
- 1 position-rails: modular equipment
- Adjustable rails (3 positions): modular equipment, DRX, DPX<sup>3</sup> 160/250.

#### Plates

To mount your devices, use pipe-nuts, nuts or directly screw your fixing screws on the plate.

After having installed the device on the plate (tightening torque 1 N.m. for all the devices, except SPX-D → 2 N.m.) it is essential to bend the retaining brackets and then to clip them on the enclosure's uprights.

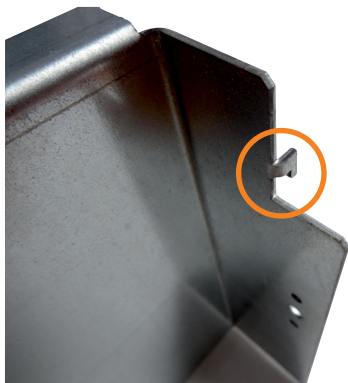

The XL Pro<sup>3</sup> software automatically gives you the positions of the plates and rails depending on the implementation. Dimensions indicated by XL Pro<sup>3</sup> are given in relation to the zero point located under the upper crosspiece of your enclosure's structure.

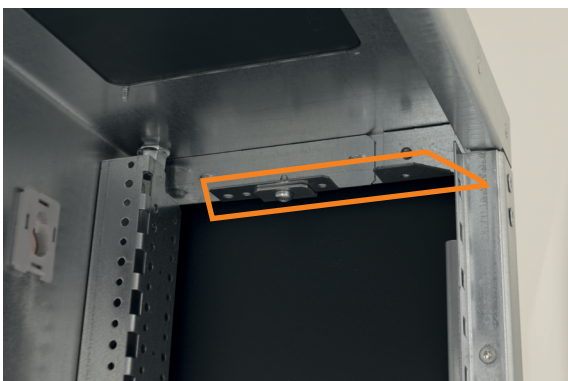

The plate's plan defines the good position of the plates.

Insert the anti-rotation studs in the smaller holes of the enclosure, then position your auto-tapping screws and tighten: Torx key S30, tightening torque 8 N.m. Repeat these two operations for other fixing points (2 or 4).

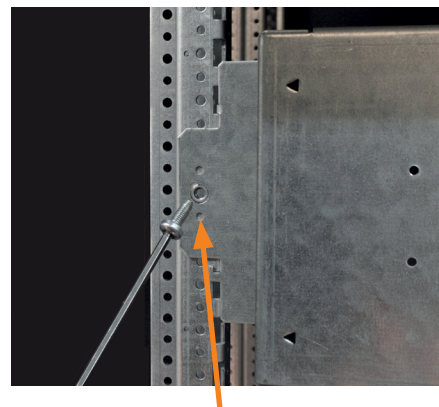

anti-rotation stud

#### UNIVERSAL PLAIN AND PERFORATED PLATES

	Plain			
Height	200mm	300mm	400mm	600mm
16 modules	3 395 40	3 395 41	3 395 42	3 395 43
24 modules	3 395 44	3 395 45	3 395 46	3 395 47
36 modules	3 395 48	3 395 49	3 395 50	3 395 51
	Perforated			
Height	200mm	300mm	400mm	600mm
16 modules	3 395 60	3 395 61	3 395 62	3 395 63
24 modules	3 395 64	3 395 65	3 395 66	3 395 67
36 modules	3 395 68	3 395 69	3 395 70	3 395 71

They are both delivered with 2 auto-tapping screws and must be fixed on the functional uprights like a basic plates. The differences are there are no anti-rotation studs and 4 retaining brackets are available instead of 2.

Example of the plate Cat.No 3 395 41:



## ▪ The 1-position rails

These rails are pre-assembled and allow the mounting of modular devices.

There are 3 references depending on the width of the enclosure:

- 3 382 21: for 16 modules enclosure
- 3 382 24: for 24 modules enclosure
- 3 382 27: for 36 modules enclosure



**The minimum height of the front panel is 150mm. In this case, the top screw of the bracket must be fixed to the 3rd large hole of the structural upright. As a reminder, the larger holes are used for mounting equipments. The smaller holes are for inserting anti-rotation studs.**

After determining the height of the rail (according to the front panel plan):

1. Insert the plastic clips into the rectangular slots of the structural uprights.

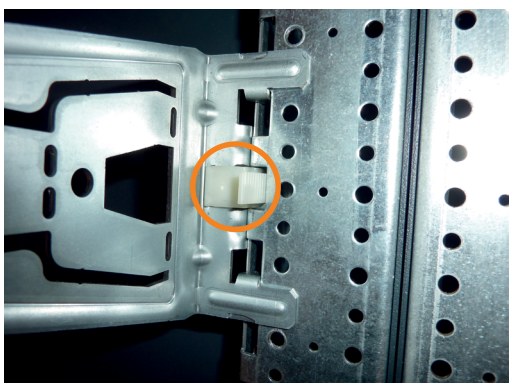

2. Fix the rail brackets to the sides of the structural uprights using the 4 screws (2 per bracket) → Torx key S30, tightening torque 8 N.m.



Cable ducts can be installed behind the rails or on the side. Their dimensions must not exceed 60 x 60mm.

It is necessary to bend the dedicated part of the rail brackets:

- Inwards so that the ducts are placed behind the rail.
- Outwards so that the ducts are placed on the side, along the structural uprights.

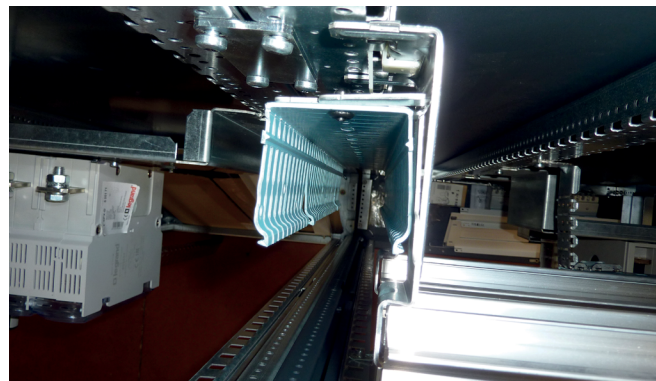

**The presence of any L-shaped coupling plates has no impact on the installation of the 1-position rails. However, flat coupling plates must be fixed vertically to avoid any mounting conflicts.**

## ▪ 3 positions rails

These rails enable the mounting of modular devices, DRX and DPX<sup>3</sup> 160/250.

There are 3 references depending on the width of the enclosure:

- 3 382 20: for 16 modules enclosure
- 3 382 23: for 24 modules enclosure
- 3 382 26: for 36 modules enclosure

## EQUIPMENT MOUNTING

### CAT.NO COMPOSITION:



1. Install the two metal brackets on each side of the rail.
2. After determining the height of the rail (according to the faceplate plan), position the brackets in the structure's uprights.



3. Insert the bracket/rail set into the two brackets in the rearmost position according to the type of product installed on the rail. This operation is performed by pushing the two flexible tabs outward. It is possible to mix products on the same row; in this case, rail height spacer will be necessary (see the next chapter).

### RAIL POSITIONS PER PRODUCT TYPE:

#### Modular devices

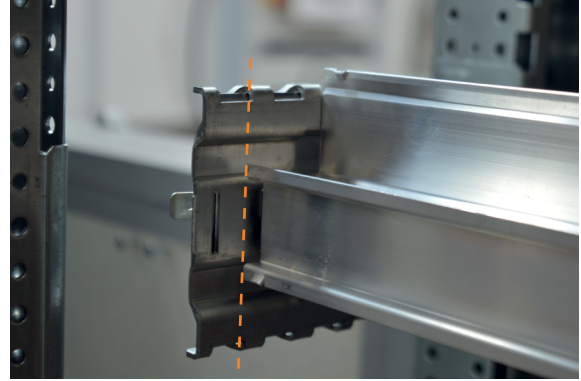

#### DRX

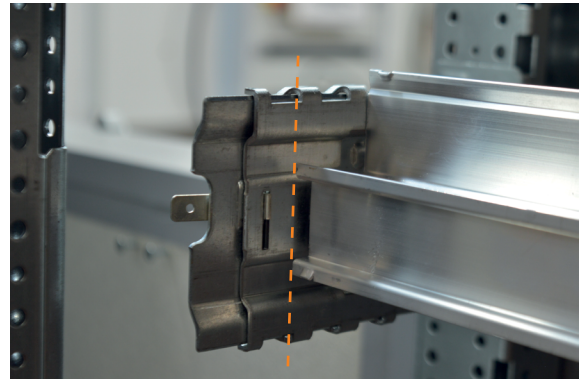

#### DPX<sup>3</sup>

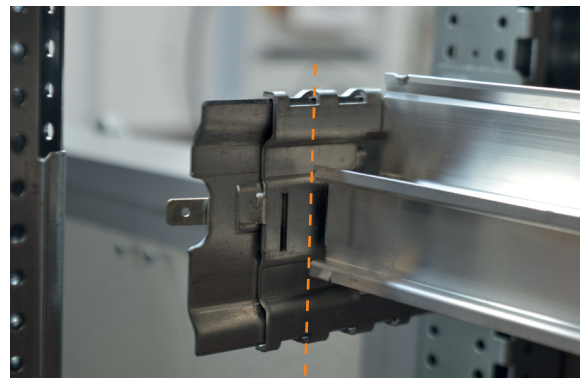

### CASE OF ENCLOSURES COUPLING:

- If the rail axis is less than 150mm from the structural crossbar, a first 50mm faceplate must be installed to allow the installation of the bracket plate.
- In the case of installing 2 rail supports with a spacing of 150mm or 200mm, the flat pairing plates must be fixed horizontally to avoid any assembly conflict. Note that in this case, we cannot fix a plate facing the flat plate in the paired enclosure.

## Rail height spacer

3 references allows to level several devices on the same rail:

### Cat.No 3 382 40:

Allows to level modular equipment and DPX<sup>3</sup> 160/250.  
In this case, position the rail on the fixing brackets at the bottom of the enclosure.

### Cat.No 3 382 41:

Allows to level modular equipment and DRX 125/250.  
In this case, position the rail in the intermediary position on the fixing brackets.

### Cat.No 3 382 42:

Allows to level DPX<sup>3</sup> 160/250 and DRX 125/250.  
In this case, position the rail on the fixing brackets at the bottom of the enclosure.  
To enable the fixing of DPX<sup>3</sup> and DRX on the rail, it is essential to equip them with adaptors, here are the Cat.Nos:

- 4 210 68: for DPX<sup>3</sup> 160 with side motor drive.
- 4 210 69: for DPX<sup>3</sup> 250 with side motor drive.
- 4 210 71: for DPX<sup>3</sup> 160 without side motor drive.
- 4 210 72: for DPX<sup>3</sup> 250 without side motor drive.
- 4 210 73: pour DPX<sup>3</sup> 160 with earth leakage without side motor drive.
- 4 210 74: pour DPX<sup>3</sup> 250 with earth leakage without side motor drive

Fixing plate for DPX<sup>3</sup>



Fixing plate for DRX

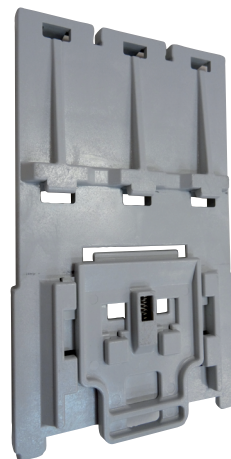

- 0 271 87: for DRX 125 3P and 4P.
- 0 271 88: for DRX 250.
- 0 271 89: for DRX 125 1P.
- 0 271 90: for DRX 125 2P.

The rail height spacer needs to be fixed on the rail. Depending on the configuration, you can cut it to adapt the length.

Example of rail height spacer mounting

Cat.No 3 382 40 :

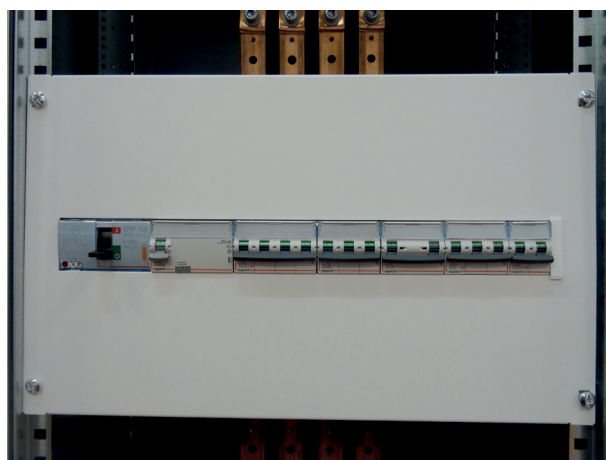
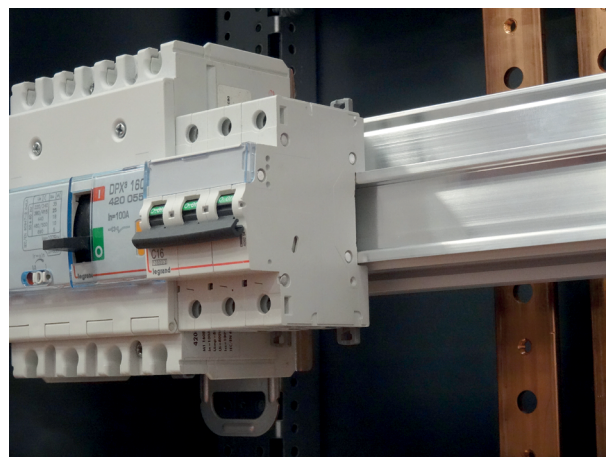

## EQUIPMENT MOUNTING

### Wire guide (Cat.No 4 052 25) mounting

Fixing the horizontal wiring guide is a quick operation and no tools are required, you only need to clip it at the back of the rails Cat.Nos 3 382 20, 3 382 23 and 3 382 26.

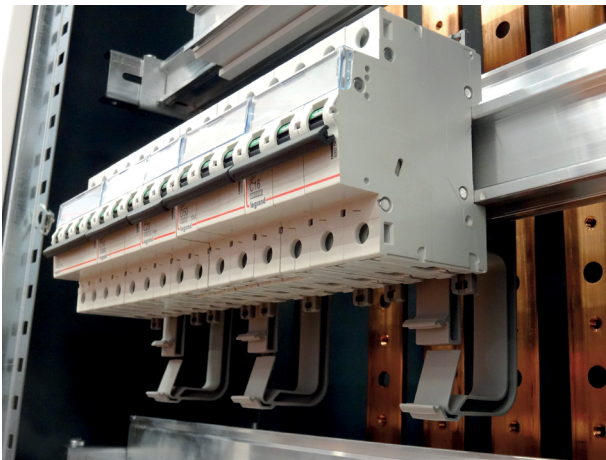

### LINA 25 duct mounting

It is possible to associate Lina 25 duct with a rail to cut 15mm thick Cat.No 0 477 23.

1. First cut the rail to the desired length:

16 modules enclosure	24 modules enclosure	36 modules enclosure
370mm	520mm	720mm

2. Fix the rail on the rear structure's uprights with 2 auto-tapping screws, Torx S30 → tightening torque 8 N.m.



3. Clip at least 2 Linafix accessories on the rail (Cat.No 0 366 40).



4. Cut the Lina duct at the length you need while considering the possible use of the vertical duct.
5. Drag the accessories to enable the locking in the duct's holes.
6. Push the duct at the maximum to the rail then turn a quarter turn the accessory with a flat screw-driver (4mm) to fix the whole

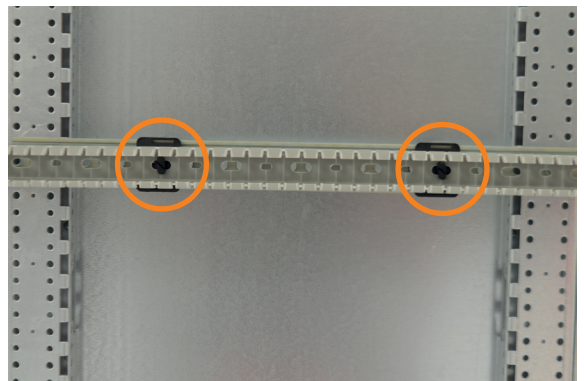



It is possible to fix the duct on the rear uprights using insulating rivets Cat.No 0 200 80.



Use the largest holes on the uprights.

Example of 2 ducts mounting (horizontal and vertical):

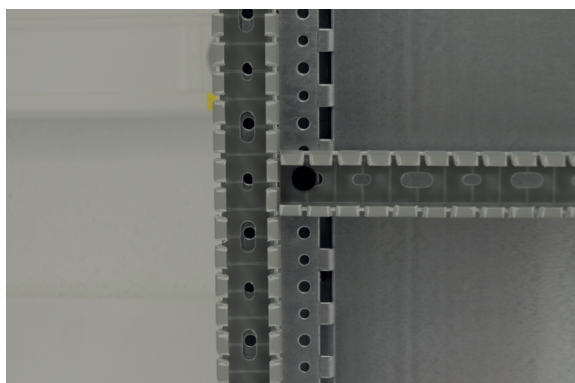

## "U shaped" wire mesh cable trays mounting

They can be installed vertically inside external cable sleeves. You need to use a set of 2 functional uprights and the wire mesh cable trays Cat.No 0 464 69.

### ▪ Functional uprights

A set of 2 functional uprights (1 Cat.No includes 2 uprights, 8 pipe-nuts and 8 crosshead screws):

Cat.No	Cable sleeve's height (mm)
3 379 86	750
3 379 87	900
3 379 88	1050
3 379 89	1200
3 379 90	1350
3 379 91	1500
3 379 92	1650
3 379 93	1800
3 379 94	1950
3 379 95	2100
3 379 95	2250

### ▪ Cable trays

Cat.No 0 464 69:

Length	Width	Thickness
3000mm	215mm (overall)	60mm (overall)

With the crosspiece Cat.No 3 379 79 (at least 2).

1. Position the 8 pipe-nuts in the functional uprights' square holes.

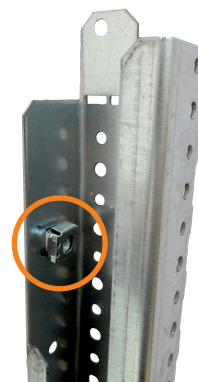

2. Remove the covers on the enclosure.
3. Position the uprights, engage the screws and tighten, Philips n°1, tightening torque 5 N.m.
4. Fix the crosspiece's brackets on the functional uprights, Torx S30 → tightening torque 8 N.m
5. Fix the crosspieces on the brackets, Torx S30, tightening torque 8 N.m.

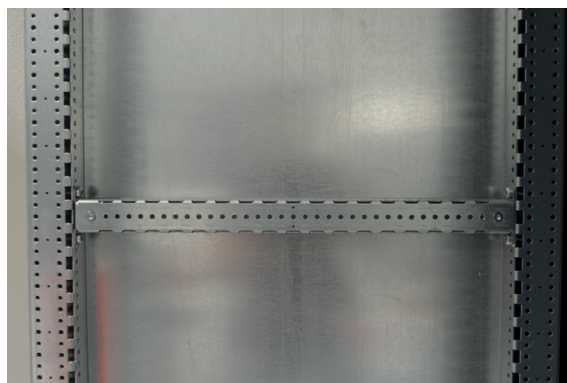

## EQUIPMENT MOUNTING

1. Cut the cable tray at the length you need.
2. Use the "U" shape parts provided with the cable tray to fix it on the crosspieces. Use the auto-tapping screws (Torx S30).
3. Tighten until the middle part of the "U" shape part bottoms in the crosspiece. The tray is fixed.

i

Use 2 "U" shape parts per crosspieces.

U shaped pieces supplied:

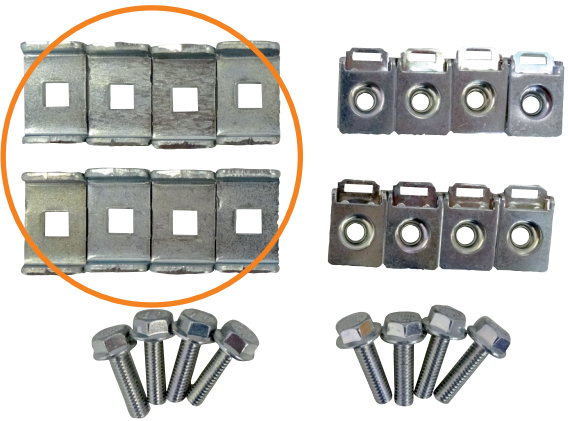

The same mounting process is possible with a 16 modules enclosure using either :

- Cable tray Cat.No 0 464 69

Length	Width	Thickness
3000mm	215mm (overall)	60mm (overall)

- or Cable tray Cat.No 0 464 70

Length	Width	Thickness
3000mm	420mm (overall)	65mm (overall)

With the crosspiece Cat.No 3 379 80.

+

Fixing cables on the tray is possible when using Colson cable ties with adapted length and width.

## Cable passage between the door and the enclosure

It can be done with :

- Braided sleeve Lina 25:
  - 0 366 38 → Ø 20mm, 50m length
  - 0 366 39 → Ø 30mm, 50m length.



- Spiral sleeving:
  - 6 361 78 → Ø 12mm;
  - 6 361 83 → Ø 22mm.





The cabling passage inside the door can be released using these references associated with self-adhesive bases: Cat.No 0 320 65 (colorless), 0 320 67 (black) or 0 320 68 (black for large rings).

Example Cat.No 0 320 67:



## Cable entry plates mounting

Entries can be installed using the plates provided with the enclosures equipped with cable glands that have a minimum IP rating of 55. Another solution is to replace these metal plates with Cabstop plates (IP 55). For rigid cables, do not strip the cable and insert them directly into the rubber entries.



**Do not forget to place your seal between the Cabstop plate and the enclosure to ensure the IP.**

For flexible cables, first make a passage through the rubber with a screwdriver to facilitate easier insertion afterward

Example of the installation (top and bottom view):



## Treating protective conductors supports mounting

The main collector is used to link:

- The main protective conductor.
- Circuits protective conductors.
- Possibly the transformer's protective conductor
- Equipotential bondings

In XL<sup>3</sup> S 630 enclosures, you can release this type of connection using the following solution (equipped with uprights Cat.No 3 397 21):

### ▪ Uprights Cat.No 3 397 21

Fix the supports on the functional uprights using the 4 crosshead screws supplied.



## EQUIPMENT MOUNTING

Fix the supports on the functional uprights using the 4 crosshead screws supplied.



2 thickness are available for the brackets: 2mm and 4mm.

### TERMINAL BLOCKS (ALONE OR IP 2X) MOUNTED ON A FLAT BAR 12 X 2mm CAT.NO 0 048 19

Insert the flat bar(s) in the indicated spaces (thickness 2mm) and clip the IP 2X terminal blocks.

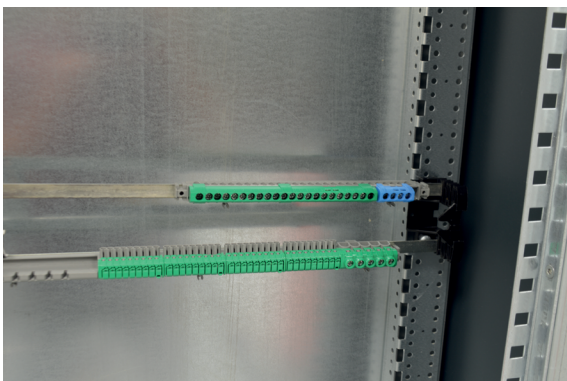
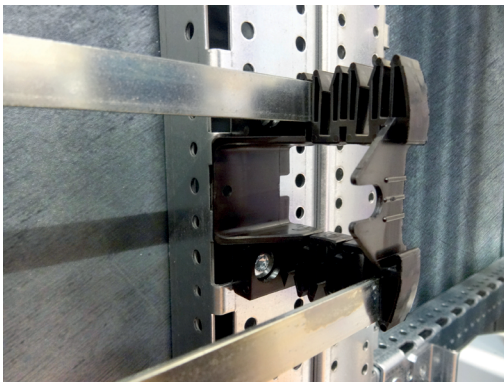

### BRASS BAR FOR 24 MODULES (CAT.NO 0 373 01) BRASS BAR FOR 36 MODULES (CAT.NO 3 397 57) COPPER BAR WITH TAPPED HOLES (CAT.NO 0 373 89)

Same mounting as the flat bar Cat.No 0 048 19 but respecting the 4mm spacing on the brackets:



### ▪ Copper bar 12 x 4mm Cat.No 0 373 49:

Same mounting as Cat.No 0 373 89



**COPPER BAR WITH TAPPED HOLES CAT.NOS  
0 374 34/38.**

Use the clips supplied.



With clips/screws on the front of the brackets:



Inserting at the bottom of the supports respecting these steps:

1. Fix a support
2. Insert the rail where indicated
3. Insert the rail in the 2<sup>nd</sup> indicated notches of the support
4. Fix your 2<sup>nd</sup> support.



Only a 27mm width bar is compatible.

Fix the bar using the 2 screws supplied with the brackets.



Example with Viking terminal block:

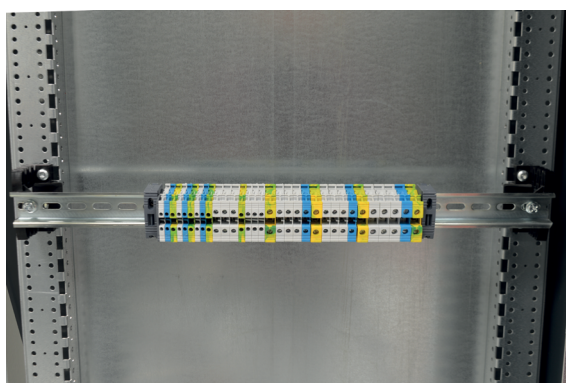

**TERMINAL BLOCKS VIKING MOUNTED ON A RAIL.**

There are two rail Cat.Nos available for the mounting:

0 374 07 → solid rail with a depth of 15mm;

0 477 23 → rail with slots of 15mm depth.

Two mounting options are possible for this rail after cutting it to the appropriate length:

## EQUIPMENT MOUNTING

### Equipotential bonding



**For all your enclosures mountings, make sure to use the largest holes to fix the equipment. Smaller holes are for inserting anti-rotation stud.**

The Cat.No 3 397 53 enables equipotential bonding, it includes:

- 1 green/yellow cable equipped with 2 rounded lugs
- 1 self-tapping screw
- 1 M6 screw;
- 2 notched washers for M6 screws
- 3 nuts for M6 screws
- 4 flat washers.

#### ▪ Of the door

The faceplates and side panels equipotential bonding are ensured by mounting elements (+ claws for faceplates). Doors equipotential bonding is automatically ensured via hinges.

When mounting electrical equipment, voltage exceeds 50 V, on the door, faceplates or side panels, it is required to conduct a complementary equipotential bonding. Use the following conductor (Cat.No 3 397 53).



**The length of the equipotential link is 350mm, its cross-section is 6mm<sup>2</sup>.**

For cable routing (and possibly wiring), we recommend installing a faceplate (located at the very top or bottom of the enclosure) equipped with a Plexo rubber grommet.

Several diameters are available:

- 20mm max. Cat.Nos 0 919 08/14;
- 25mm max. Cat.Nos 0 919 00/15;
- 32mm max. Cat.Nos 0 919 16;
- 40mm max. Cat.Nos 0 919 17.

1. Drill a hole in the faceplate according to the adapted diameter of your rubber grommet.
2. Place your plug.
3. Use your self-tapping screw with a flat washer, then fix a cable edge on the enclosure's structure crosshead.
4. Put through your cable in the rubber grommet.
5. Fix the faceplate on the faceplate's brackets.
6. Remove the cover protecting the door's dowel.
7. Position the other edge in the dowel, the washer and the nut, then block the whole.



## ▪ Of the faceplate Cat.Nos 3 397 53

1. Use a flat clip and twist the bracket on the faceplate.\*

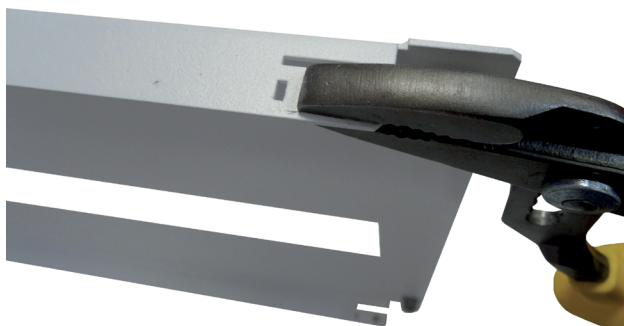

2. Use the metric screw equipped with a toothed washer then insert the whole in the bracket's hole.
3. Across the bracket, fix one edge of the cable, then the second toothed washer and the nut.
4. Tighten the whole → 8 N.m

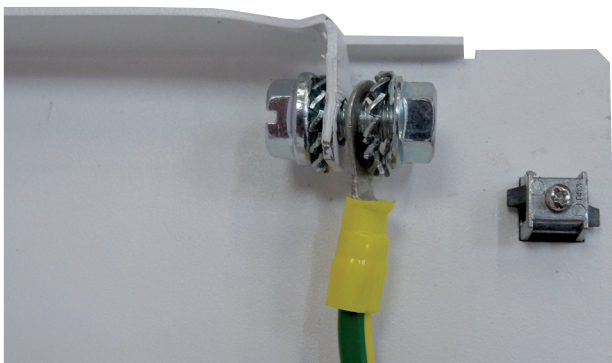

5. Use the self-tapping screw with a flat washer, fix the other edge of the cable on the enclosure's structure rear upright..

## ▪ Of the side panel

1. Remove the cover protecting the door's dowel..
2. Position the other edge in the dowel, the washer and the nut, then block the whole.
3. Take the self-tapping screw with a flat washer and attach the other end of the cable to the structural cross member of the enclosure.



## DISTRIBUTION SYSTEM

The XL<sup>3</sup> S 630 innovative distribution system enables to create several combinations of aligned and staggered set of busbars.

Thanks to a crosspiece system, installing busbars is now possible for each type of enclosure. Moreover, different positions are possible: at the bottom, sleeved, flat, staggered, vertical, horizontal crossing several enclosures joined together.

You can opt for aluminum or copper bars.

This system increases safety, speed and the optimization of the enclosure's volume.

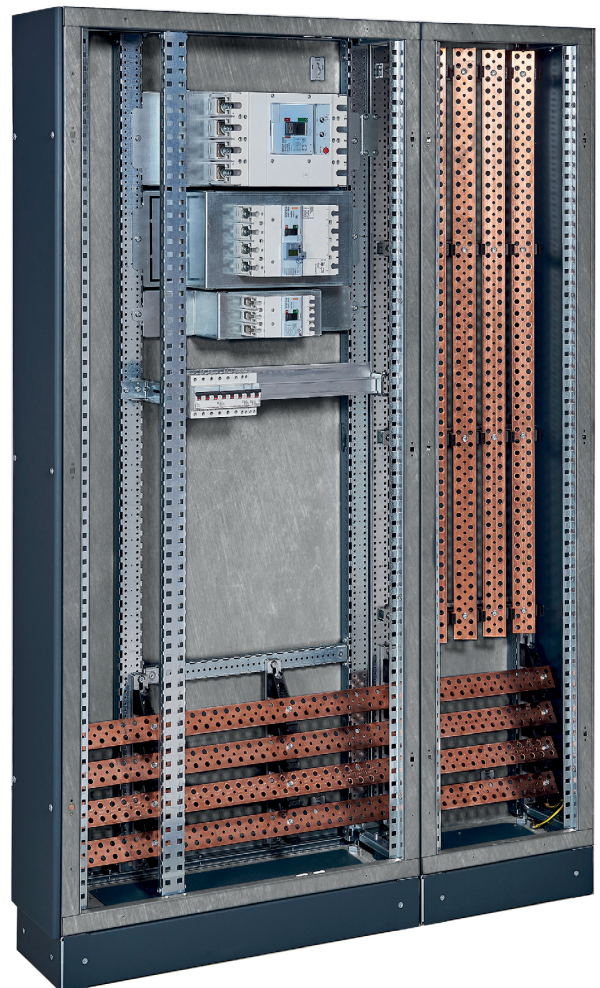



In max. (A)		Flat copper bars			"C shaped" aluminium bars		
		IP ≤ 30	450	800	700	700	
		IP > 30	400	700	700	630	
Positions		Supports					
			3 399 00	3 399 01	3 399 06	3 399 02/03	3 399 04/05
	Vertical at the back of the sleeve	L: 450mm	3 399 00 + 3 379 80	-	3 399 06	3 399 02/03 + 3 379 80	-
				Vertical at the back of the enclosure	L: 16 modules	-	-
L: 24 modules	-	3 399 01 + 3 379 81			-	-	3 399 04/05 + 3 379 81
L: 36 modules	-	3 399 01 + 3 379 82			-	-	3 399 04/05 + 3 379 82
	Horizontal at the back of the enclosure	In sleeve L: 350mm	3 399 00 + 3 379 79 x 2 <sup>(1)</sup>	-	3 399 06 + 3 379 79 x 2 <sup>(1)</sup>	3 399 02/03 + 3 379 79 x 2 <sup>(1)</sup>	-
		L: 16 modules	3 399 00 + 3 379 80 x 2 <sup>(1)</sup>	-	3 399 06 + 3 379 80 x 2 <sup>(1)</sup>	3 399 02/03 + 3 379 80 x 2 <sup>(1)</sup>	-
		L: 24 modules	3 399 00 + 3 379 81 x 2 <sup>(1)</sup>	-	3 399 06 + 3 379 81 x 2 <sup>(1)</sup>	3 399 02/03 + 3 379 81 x 2 <sup>(1)</sup>	-
		L: 36 modules	3 399 00 + 3 379 82 x 2 <sup>(1)</sup>	-	3 399 06 + 3 379 82 x 2 <sup>(1)</sup>	3 399 02/03 + 3 379 82 x 2 <sup>(1)</sup>	-

<sup>(1)</sup> Only when adding supports fixed between functional uprights (Ipk's function targeted)

## Set of busbars mounting



For all your enclosures mountings, make sure to use the largest holes to fix the equipment. Smaller holes are for inserting anti-rotation stud.

Composition Cat.No 3 399 01:

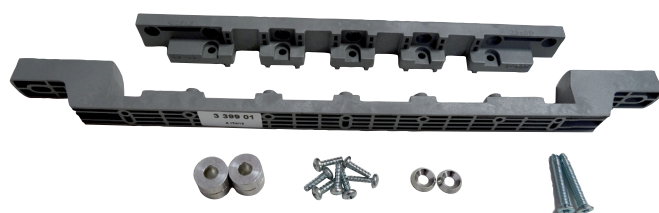

Composition Cat.No 3 379 81:



### ▪ Fixing flat copper bars on brackets Cat.No 3 399 01

Brackets for aligned bars 400A maxi.

The installation is on the crosspiece  
Cat.No 3 379 81 (24 modules) or 3 379 82 (36 modules) to  
create a set of vertical busbars at the back of your 24 modules  
or 36 modules enclosures.

First, position the crosspieces' fixing brackets on the  
functional uprights (2 screws/bracket, Torx key S30,  
tightening torque 8 N.m.).

## DISTRIBUTION SYSTEM

Right side of the enclosure:

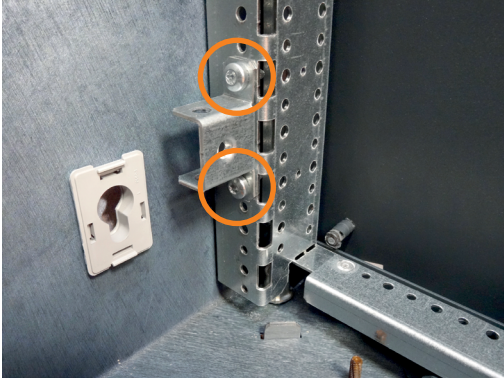

1. Fix the crosspiece on the brackets (1 screw/bracket, Torx key S30, tightening torque 8 N.m.)



2. Fix the rear part of the support on the crosspiece using 2 big screws, 2 washers and 2 spacers (to position between the support and the crosspiece), Torx key S30, tightening torque 8 N.m.

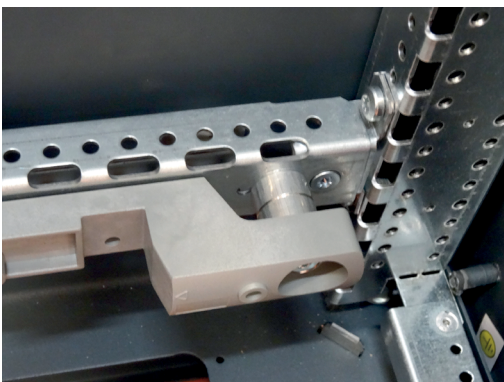

**3 dimensions of copper bars are available:**

- 18mm x 4mm (Cat.No 0 374 34).
- 25mm x 5mm (Cat.No 0 374 18).
- 32mm x 5mm (Cat.No 0 374 19).

18mm x 4mm (front view):



18mm x 4mm (top view):

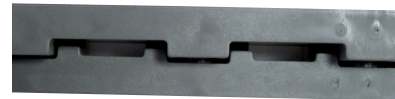

25mm x 5mm (front view):



25mm x 5mm (top view):

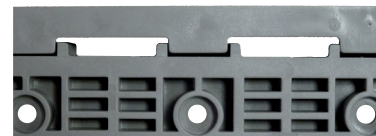

32mm x 5mm (front view):



32mm x 5mm (top view):

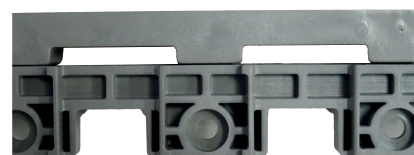

After having installed the supports, cut the bars at needed length.

3. Position the bars inside the supports, then position the front face respecting the good dimension of the bars (see above).
4. Fix this 2nd part using 5 screws → imprint PZ1.

**It is possible to fix a protective cover on the supports (Plexiglas or other) using 2 screws per supports → imprint PZ1.**

**Screws position:**

### BARS MAXIMUM INTENSITY ACCORDING TO THEIR DIMENSIONS AND THE ENCLOSURE'S IP

		I (A)	
		IP ≤ 30	IP > 30
	<b>0 374 34<sup>(1)</sup></b> 18 x 4	245	200
	<b>0 374 18<sup>(2)</sup></b> 25 x 5	330	270
	<b>0 374 19<sup>(2)</sup></b> 32 x 5	450	400

- (1) M6 6 Nm
- (2) M6 7,5 Nm

**i**

**Space between the bars and the bottom of the enclosure: 45mm.**

**Space between the crosspiece and the bottom of the enclosure: 10mm**

### MAXIMUM DISTANCE BETWEEN 2 SUPPORTS ACCORDING TO BARS DIMENSIONS AND THE IPK

		Ipk (kA)									
		10	15	20	25	30	40	50	60	70	80
	<b>0 374 34<sup>(1)</sup></b> 18 x 4	1000	700	550	400	350	250	200	200	150	150
	<b>0 374 18<sup>(2)</sup></b> 25 x 5	1200	1000	750	600	500	350	300	250	200	200
	<b>0 374 19<sup>(2)</sup></b> 32 x 5	1500	1200	950	750	650	450	400	300	250	250

- (1) M6 6 Nm
- (2) M6 7,5 Nm

### Fixing flat copper bars on supports Cat.No 3 399 06

Brackets for sloped bars 630 A/800 A  
Composition Cat.No 3 399 06



The installation can be done directly on:

- Functional uprights to create a set of vertical bars at the back of the sleeve width 450mm.
- Functional uprights to create a set of horizontal bars at the back of the enclosure.

According to the Ipk already defined, it is required to add intermediate supports between functional uprights. In this case, you need to add 2 crosspieces to fix them.

These are the references:

- 3 379 79: cable sleeves
- 3 379 80: 16 modules enclosures
- 3 379 81: 24 modules enclosures
- 3 379 82: 36 modules enclosures

## DISTRIBUTION SYSTEM



5 copper bars dimensions are available:

- 18mm x 4mm (Cat.No 0 374 34).
- 25mm x 5mm (Cat.No 0 374 18).
- 32mm x 5mm (Cat.No 0 374 19).
- 50mm x 5mm (Cat.No 0 374 40).
- 63mm x 5mm (Cat.No 0 374 41).



Position the plastic washers between the bars and the supports, for bars dimensions 50mm x 5mm; and 63mm x 5mm.

### VERTICAL BUSBARS MOUNTING

1. Fix the supports on the functional uprights using 2 screws, → Torx key S30, tightening torque 8 N.m.

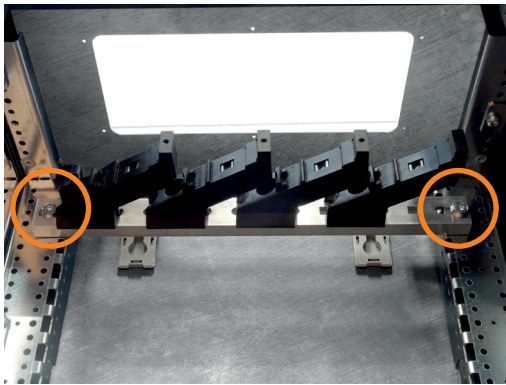

2. After having installed all the supports needed, cut the bars at length needed.

3. Fix the bars on the supports using 4 screws (supplied) per support, → hexagonal socket 10mm, tightening torque 7 N.m.

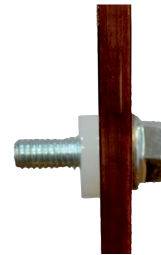
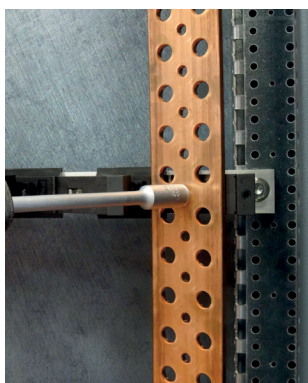

### HORIZONTAL BUSBARS MOUNTING

The supports need to be fixed on the same way as in vertical position (on functional upright), 2 screws → Torx S30, tightening torque 8 N.m.

According to the Ipk, it can be required to mount supports between functional uprights using crosspieces (references mentioned above). Fixing bars on supports is the same as the vertical version.

Mounting example:

Functional upright

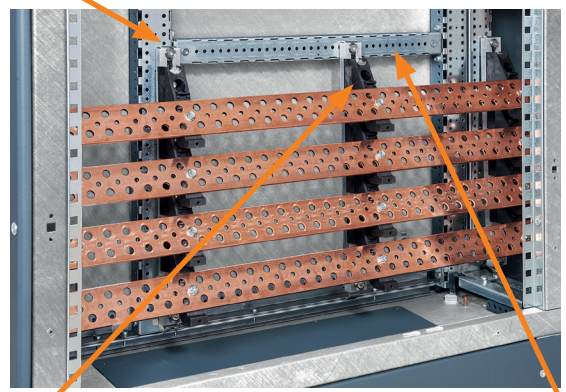

Intermediary support

Crosspiece



It is possible to fix a protective cover on the supports (Plexiglas or other) using 2 screws per supports, → imprint PZ1.

Screws position:

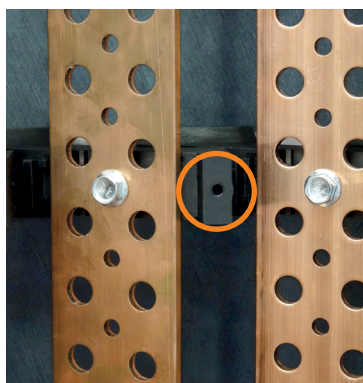

### BARS MAXIMUM INTENSITY ACCORDING TO DIMENSIONS, POSITIONS AND THE ENCLOSURE'S IP:

		I (A)		I (A)	
		IP ≤ 30	IP > 30	IP ≤ 30	IP > 30
	<b>0 374 34<sup>(1)</sup></b> 18 x 4	245	200	245	200
	<b>0 374 18<sup>(2)</sup></b> 25 x 5	330	270	330	270
	<b>0 374 19<sup>(2)</sup></b> 32 x 5	450	400	450	400
	<b>0 374 40</b> 50 x 5	700	630	630	550
	<b>0 374 41</b> 63 x 5	800	700	720	630

(1) M6 6Nm  
(2) M6 7,5Nm

### MAXIMUM DISTANCE BETWEEN 2 SUPPORTS ACCORDING TO BARS DIMENSIONS AND THE IPK:

		Ipk (kA)											
		10	15	20	25	30	35	40	45	50	60	70	80
	<b>0 374 34<sup>(1)</sup></b> 18 x 4	800	400	300	250	225	200	175	150	150	125	100	-
	<b>0 374 18<sup>(2)</sup></b> 25 x 5	800	600	450	350	300	250	200	200	150	125	100	-
	<b>0 374 19<sup>(2)</sup></b> 32 x 5	900	600	500	400	350	300	250	200	150	125	100	-
	<b>0 374 40</b> 50 x 5	-	700	600	500	400	350	275	225	200	150	150	100
	<b>0 374 41</b> 63 x 5	-	800	700	550	450	400	300	250	200	150	150	100

(1) M6 6Nm  
(2) M6 7,5Nm

### ▪ Bracket Cat.No 3 399 00 mounting

Sloped and staggered bars 400A maxi.

#### VERTICAL BUSBARS MOUNTING



The vertical busbars mounting is only for 16 modules enclosure.

The mounting is the same as Cat.No 3 399 06 but add the crosspiece Cat.No 3 379 80 for each bracket mounting (respect the right position of each accessory). See mounting page 40. Center the supports on the crosspieces.



Ensure that the supports are properly centered on the crosspieces.



When fixing bars on supports use hexagonal head screws 10mm → tightening torque 10 N.m.

#### HORIZONTAL BUSBARS MOUNTING



The horizontal busbars mounting is adapted for all widths and including cable sleeves

## DISTRIBUTION SYSTEM

According to the Ipk, it may be required to add intermediary supports between functional uprights. In this case, add 2 crosspieces to fix them (see p.40).

Here are the Cat.Nos needed:

- 3 379 79: cable sleeves
- 3 379 80: 16 modules enclosures.
- 3 379 81: 24 modules enclosures.
- 3 379 82: 36 modules enclosures.

Composition Cat.No 3 399 00:

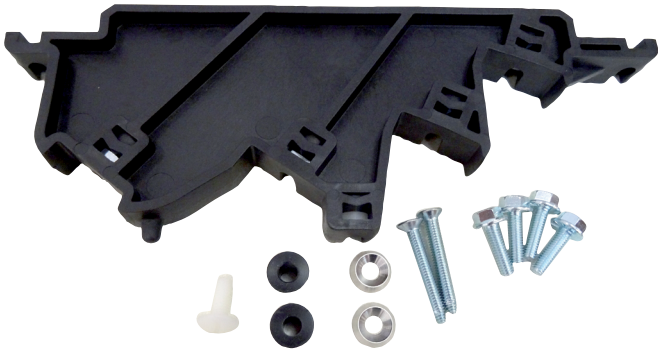

+

4 dimensions of copper bars are available for this bracket:



- 18mm x 4mm (Cat.No 0 374 34).
- 25mm x 4mm (Cat.No 0 374 38).
- 25mm x 5mm (Cat.No 0 374 18).
- 32mm x 5mm (Cat.No 0 374 19).

It is possible to fix a protective cover (Plexiglas or other) on the supports using 1 plastic screw (supplied) per support, → Flat screw-driver 6mm.

Insulating protections (Cat.No 0 373 11) can be positioned on bars (between the supports), which enables to increase the cable's section (especially equipped with connectors):

- Without protection →  $\leq 50 \text{ mm}^2$ .
- With protection →  $\leq 70 \text{ mm}^2$ .

### BARS MAXIMUM INTENSITY ACCORDING TO THEIR DIMENSIONS, POSITIONS AND THE ENCLOSURE'S IP:

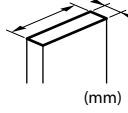
		 I (A)		 I (A)	
		IP ≤ 30	IP > 30	IP ≤ 30	IP > 30
	<b>0 374 34<sup>(1)</sup></b> 18 x 4	245	200	245	200
	<b>0 374 38<sup>(2)</sup></b> 25 x 4	280	250	280	250
	<b>0 374 18<sup>(2)</sup></b> 25 x 5	330	270	330	270
	<b>0 374 19</b> 32 x 5	450	400	450	400

(1) M6 6 Nm

(2) M6 7,5 Nm

### MAXIMUM DISTANCE BETWEEN 2 SUPPORTS ACCORDING TO BARS DIMENSIONS AND THE IPK:

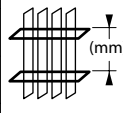
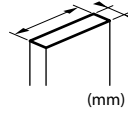
		Ipk (kA)											
		10	15	20	25	30	35	40	45	50	55	60	
	<b>0 374 34<sup>(1)</sup></b> 18 x 4	550	400	300	250	200	150	150	-	-	-	-	
	<b>0 374 38<sup>(2)</sup></b> 25 x 4	650	600	450	350	300	250	200	150	150	100	-	
	<b>0 374 18<sup>(2)</sup></b> 25 x 5	800	700	550	400	350	300	300	200	175	150	150	
	<b>0 374 19</b> 32 x 5	900	800	700	500	400	350	300	200	100	100	-	

(1) M6 6 Nm

(2) M6 7,5 Nm

## ▪ Mounting of "C-shaped" aluminum bars on support Cat.No 3 399 02/03 (heel)

Staggered 630 A maxi.

The installation can be done:

- Vertically only an 16 modules enclosure.
- Horizontally for all widths including cable sleeves.

According to the Ipk, it may be required to add intermediary supports between the functional uprights. In this case, add 2 crosspieces to fix them (see p.40).

Here are the Cat.Nos needed:

- 3 379 79: Cable sleeves.
- 3 379 80: 16 modules enclosures.
- 3 379 81: 24 modules enclosures.
- 3 379 82: 36 modules enclosures.

Composition Cat.No 3 399 02:

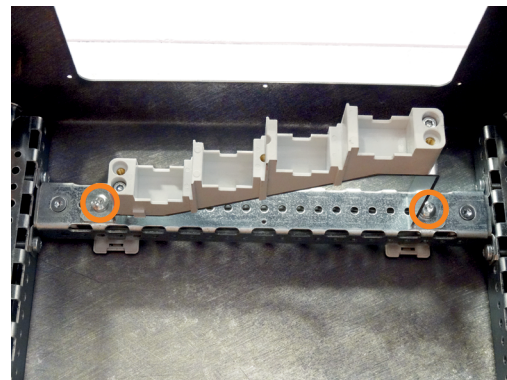
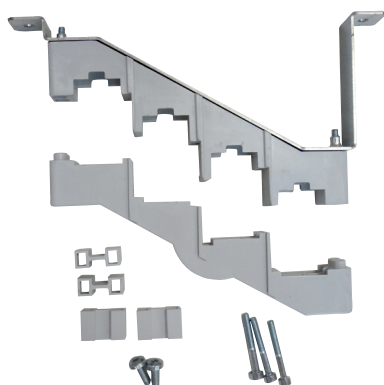

2. After having installed all the required supports, position the plastic parts in the supports except the ones corresponding to Cat.No 3 399 03, at the bottom of the enclosure

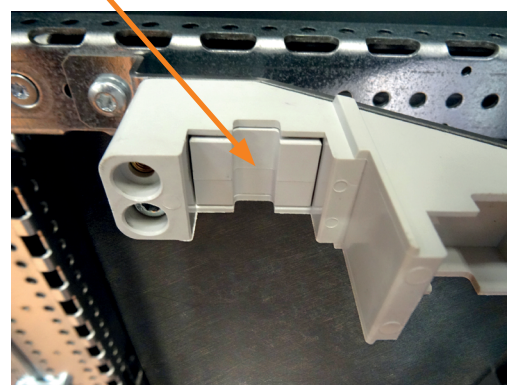

3. If needed, cut the aluminum bars at desired length
4. Take the aluminum bars and insert the plastic parts in the hub support (pay attention to the position):



**3 aluminium busbars Cat.Nos are available for this bracket:**

- 4 044 30 (up to 320A\*).
- 4 044 31 (up to 500A\*).
- 4 044 32 (up to 700A\*).

\*Mounted in an enclosure with an IP ≤ 30.

### VERTICAL BUSBARS MOUNTING

1. Fix the rear part of the brackets on the crosspieces Cat.No 3 379 80 (See p.40) using 2 screws, → Torx key S30, tightening torque 8 N.m.



**Ensure that the supports are properly centered on the crosspieces.**

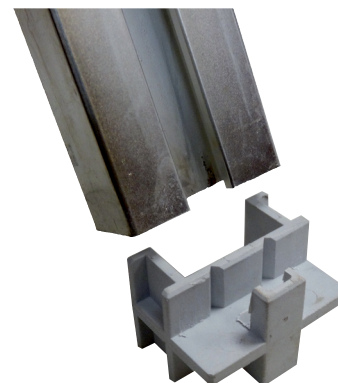

## DISTRIBUTION SYSTEM

5. Insert the assembly into the heel support, then press the bars against all other supports.
6. Fix the front face parts of all the supports using 3 screws per support, → key 4mm hex key, tightening torque 7 N.m.

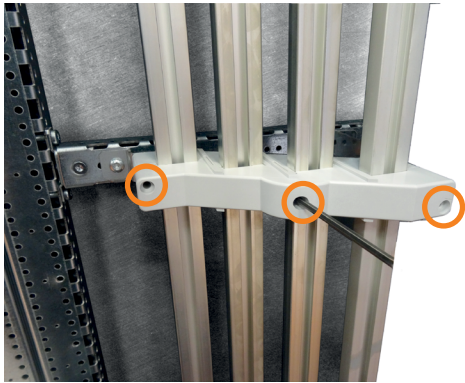



### HORIZONTAL BUSBARS MOUNTING

Supports are directly fixed on the functional uprights, using 2 screws per support, → Torx S30, tightening torque 8 N.m.

According to the  $I_{pk}$ , it may be required to add intermediary supports between functional uprights. In this case, add crosspieces to fix them (see p.40).

The procedure of fixing busbars on the supports is the same as the vertical mounting.

### BARS MAXIMUM INTENSITY ACCORDING TO DIMENSIONS, POSITIONS AND THE ENCLOSURE'S IP:

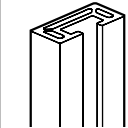
		 I (A)		 I (A)	
		IP ≤ 30	IP > 30	IP ≤ 30	IP > 30
	<b>4 044 30</b>	320	250	320	250
	<b>4 044 31</b>	500	400	500	400
	<b>4 044 32</b>	700	630	700	630

### ▪ Mounting of "C-shaped" aluminum bars on support Cat.No 3 399 04/05 (heel)

Aligned bars 630 A maxi.

The installation can be done vertically at the back of the enclosure (16 modules, 24 modules, 36 modules) using crosspieces :

- Cat.No 3 379 80: 16 modules enclosures,
- Cat.No 3 379 81: 24 modules enclosures
- Cat.No 3 379 82: 36 modules enclosures

Composition Cat.No 3 399 04 :

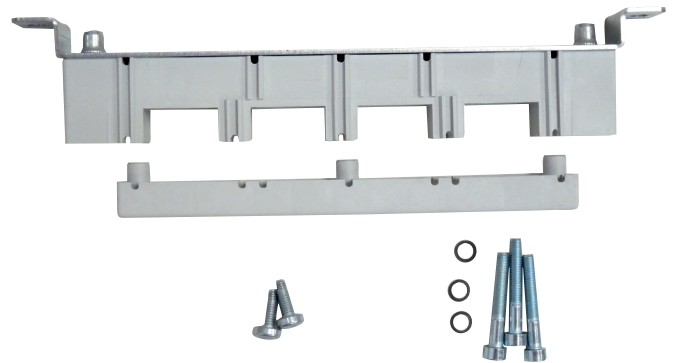

**3 aluminum bars are available for this bracket:**

- **4 044 30 (up to 320A\*).**
- **4 044 31 (up to 500A\*).**
- **4 044 32 (up to 700A\*).**

**\*Mounted in an enclosure with an IP ≤ 30.**

1. Install all the crosspieces needed on the functional uprights (see page 40)
2. Fix the rear part of the brackets on the crosspieces making sure to position the hub support (Cat.No 3 399 05) on the last crosspiece at the bottom of the enclosure. → 2 screws per support, Torx key S30, tightening torque 8 N.m..

### MAXIMUM DISTANCE BETWEEN 2 SUPPORTS ACCORDING TO BARS DIMENSIONS AND THE IPK

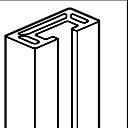
		I <sub>pk</sub> (kA)											
		10	15	20	25	30	35	40	45	50	60	70	80
	<b>4 044 30</b>	1600	1200	800	600	400	350	300	250	250	-	-	-
	<b>4 044 31</b>	1600	1200	800	650	500	450	400	350	300	250	175	100
	<b>4 044 32</b>	1600	1200	800	650	500	450	400	350	300	250	175	100

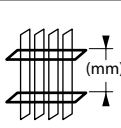





Ensure that the supports are properly centered on the crosspieces.

Mounting example of the rear part of the hub support:

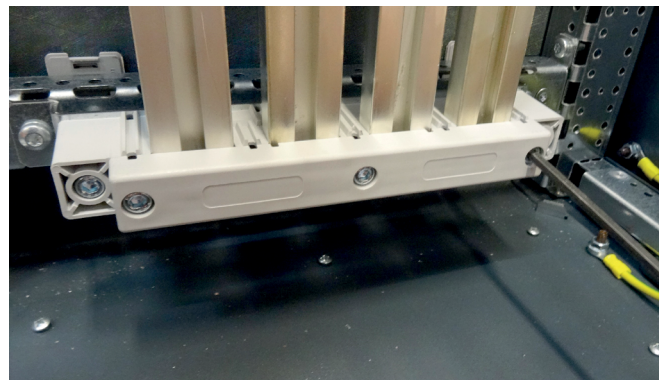
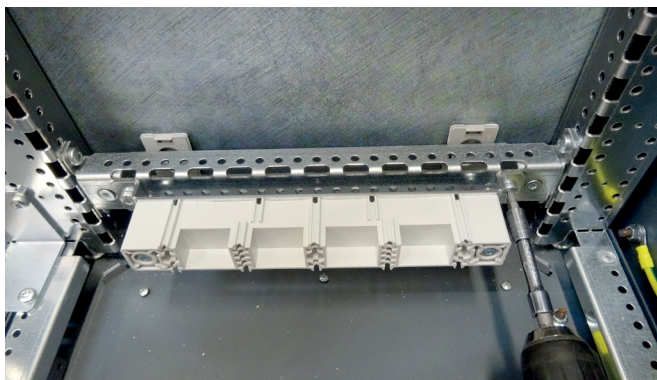

**BARS MAXIMUM INTENSITY ACCORDING TO DIMENSIONS, POSITIONS AND THE ENCLOSURE'S IP:**



If needed, cut the aluminum bars at desired length

3. Position the aluminum bars leaning on the hub support, then attach them on the other supports.
4. Fix all the front face parts of the supports using 3 screws (supplied) per support, → 5mm hex key, tightening torque 7 N.m.

		I (A)	
		IP ≤ 30	IP > 30
	<b>4 044 30</b>	320	250
	<b>4 044 31</b>	500	400
	<b>4 044 32</b>	700	630

**MAXIMUM DISTANCE BETWEEN 2 SUPPORTS ACCORDING TO BARS REFERENCES AND THE IPK**

		Ipk (kA)												
		10	15	20	25	30	35	40	45	50	60	70	80	
	<b>4 044 30</b>	1600	1200	800	600	400	400	300	300	250	-	-	-	
	<b>4 044 31</b>	1600	1200	800	650	525	525	400	400	300	250	175	100	
	<b>4 044 32</b>	1600	1200	800	650	525	525	400	400	300	250	175	100	



Space between the bars and the bottom of the enclosure: 74mm.  
Space between the crosspiece and the bottom of the enclosure: 10mm.

## INSTALLATION AND FINISHING

### Faceplate installation

There is only 1 type of faceplate installation:

→ with screws (Cat.No 3 397 02, set of 100).

Each Cat.No is composed of 100 screws, 100 plastic washers, 100 cage nuts and 25 earthing claws.

1. Insert the screws in the square holes of your faceplate, then engage the plastic washers at the back.

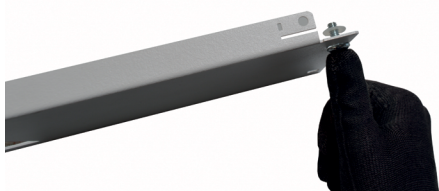

2. Place the right numbers of cage nuts on the faceplate bracket.



3. Insert an earth claw 30mm lower than one of the 2 top cage-nuts.



4. Fix the faceplate while tightening the screws, → Pozidriv n°3, tightening torque 5 N.m.

### Mounting the handle on the door

#### ▪ Mounting a handle on a 750mm - 1200mm height door

1. Separate the 4 parts composing your handle as mentioned on the instruction sheet.

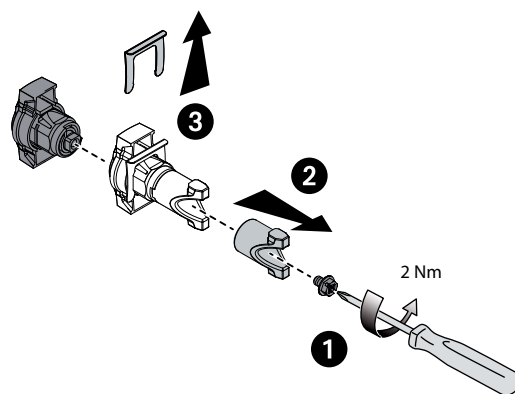

2. Place the handle on the door.
3. Fix the metallic clip
4. position the lock bracket and lock the handle with the screw, → Pozidriv n°2, tightening torque 2 N.m.

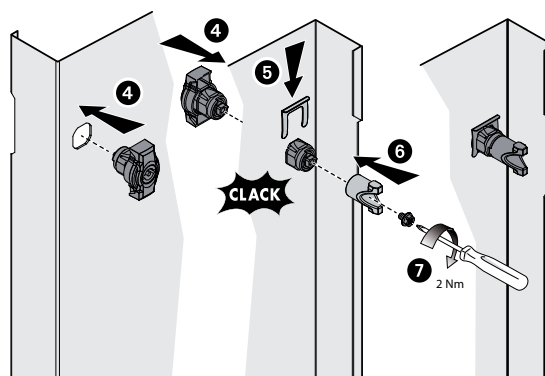

#### ▪ Mounting a handle on a 1350mm - 2250mm door

The handle for doors with a height between 1350mm and 2250mm is delivered pre-assembled. Its installation on the door is done by clipping.

## Mounting the door on the enclosure

### ▪ Mounting a 750 mm - 1200 mm door



Doors are reversible, they can be opened on the left or right side.

To proceed:

- Change the side of the metallic lock bracket and hinges,
- Turn 180° (and the handle for doors from 1350mm to 2250mm).

The maximum opening of the doors is 180°.



#### DOORS CHARACTERISTICS

Height from 750mm to 1200mm

- 2 small handles without linkage
- 2 lock bolts
- 2 hinges

Height from 1350mm to 2250mm:

- 1 large handle with linkage
- 3 lock bolts
- 3 hinges

Composition of the Cat.No for a door between 750mm and 1200mm height:

- 1 door
- 2 metallic lock brackets
- 2 hinges with 2 axes
- 2 handles
- 4 cage-nuts
- 4 screws

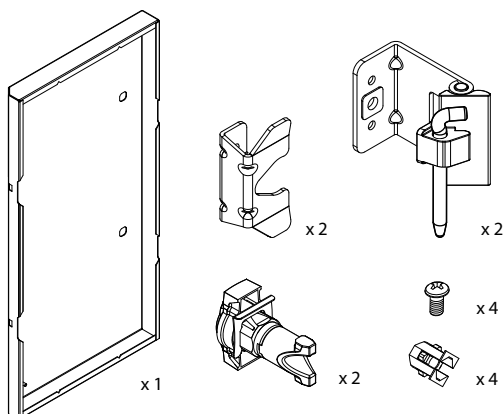

Composition of the Cat.No for a door between 1350mm and 2250mm height:

- 1 door.
- 3 metallic lock brackets.
- 3 hinges with 3 axes.
- 1 handle.
- 2 securing clips.
- 1 plastic cover.
- 6 cage-nuts.
- 6 screws.
- 2 bars with brackets.

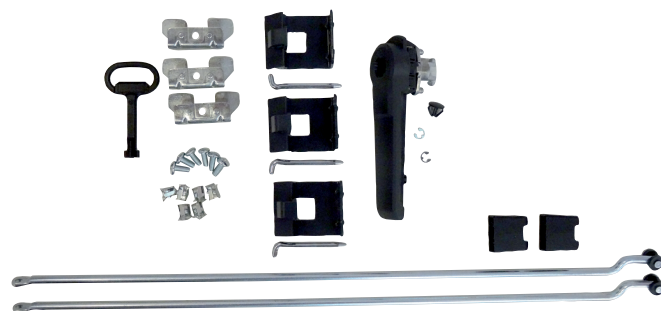

Identify correctly the need before starting mounting (left or right opening).



Hinges and metallic lock brackets mounting are identical regardless of the door height. Only the handle and bar mountings are different.

## INSTALLATION AND FINISHING



1. Position the 6 pipe-nuts in the square holes (on the hinges side).
2. Fix the 3 hinges and the 3 lock brackets (away from the hinges) on your enclosure with the provided screws → Pozidriv n°3, tightening torque 8 N.m.



3. Insert the door into the hinges and secure the assembly using the provided pins.



4. Close the door and check the closing.

Vertical key: the door is open (not locked out).



Horizontal key: the door is closed (locked out).



### ▪ Mounting a 750 mm - 1200 mm door

When you identified the need (right or left side opening), mount the handle and bar.

1. Position the handle by fixing (away from hinges) with the mechanic part upward and the plastic cover in the blank hole above.



2. Insert each bar in a black plastic bracket respecting the correct direction.



3. Insert correctly and at its maximum the 2 brackets in the door plugs. Then push the upper bracket down (push the lower bracket up) to lock the whole.

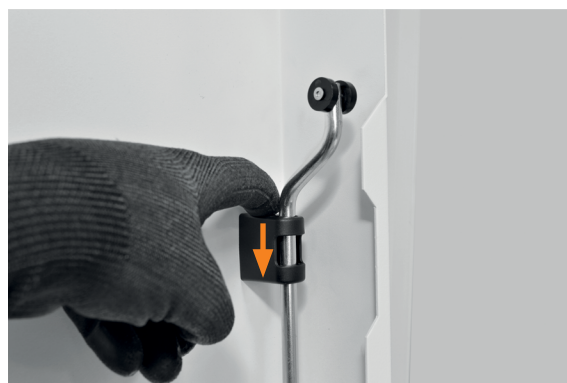

4. Insert the bars edges in the handle plugs, then, position the securing clips to lock the assembly.



## INSTALLATION AND FINISHING

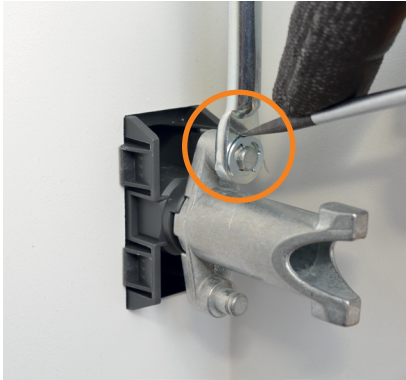

1. Position your cage-nuts in the upright's holes.



2. Assemble one vertical edge with one horizontal edge, while making sure to insert them in the tab of the slot.

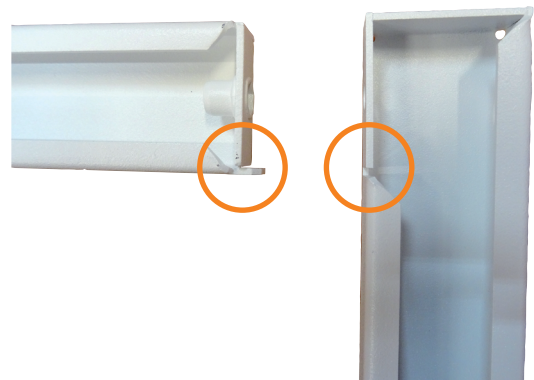

Overview of the right direction:



## IP 30 finishing kit

i

2 Cat.Nos to order → check range tables

1<sup>st</sup> Cat.No: vertical installation finishing kit.  
Composition: 2 metallic caps+screws+ cage-nuts.  
2<sup>nd</sup> Cat.No: horizontal installation finishing kit.  
Composition: 2 metallic caps+screws+ cage-nuts.

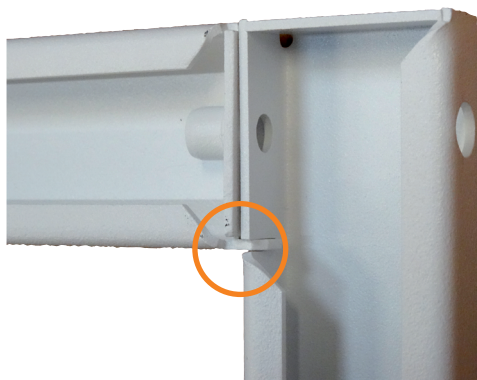

3. Position the screw provided with the horizontal edge and tighten → Pozidriv n°3, tightening torque 8 N.m.



Please repeat for the 3 other angles.  
When the frame is assembled, fix it onto your enclosure with the screws provided with the vertical edges, → Pozidriv n°3, tightening torque 5 N.m.



Make sure to position the logo in the right direction.



To ensure the IP, seal the holes of the vertical cap with the plastic cap provided.

## OTHER ACCESSORIES

### 5 modules (Cat.No 0 016 60) and 24 modules (Cat.No 3 397 54) blanking plates

Blanking plates enable to fill XL<sup>3</sup> S 630 faceplates modular windows.

You can use 5 Modules blanking plates Cat.No 0 016 60, white RAL9003, scored in a half-module.

You can also use 24 Modules blanking plates Cat.No 3 397 54.

#### ▪ Mounting blanking plate Cat.No 0 016 60

1. Insert the lower part of your blanking plate in the modular window



2. Clip the upper part by pushing it towards the faceplate



#### ▪ Mounting blanking plate Cat.No. 3 397 54

1. Insert whether the upper or lower part of your blanking plate in the modular window



2. Clip the upper part by pushing it towards the faceplate

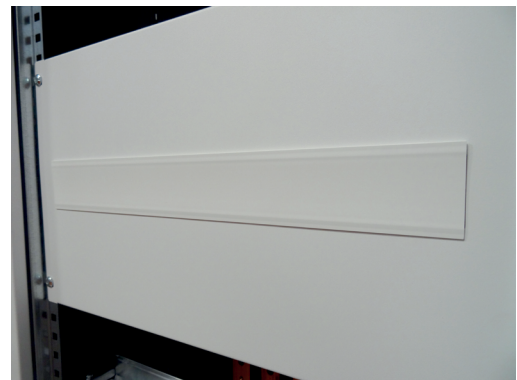

### Open document holder

There are 4 types of open documents holders :

- Open width 340 x 235 (Cat.No 0 365 80).
- Open width 260 x 165 (Cat.No 0 365 81).
- Close IP 50 width 324 x 120 (Cat.No 0 365 82).
- Flexible width 305 x 220 (Cat.No 0 097 99).

Self-adhesive open document holders enable to keep inside your enclosure the electric plans, technical sheets, installation instructions...

The latter are fixed inside the enclosure, on the door.

#### ▪ Mounting of a document

Take off the plastic protection from the double-sided adhesives positioned at the back of your holder. Then, stick it where wanted, on the door.



## Faceplate's label holders

More than label-holders on our products, you can have a 24 modules self-adhesive label holder to clip Cat.No 3 397 55 and 36 modules Cat.No 3 397 56.

Those products are delivered with a label sheet.

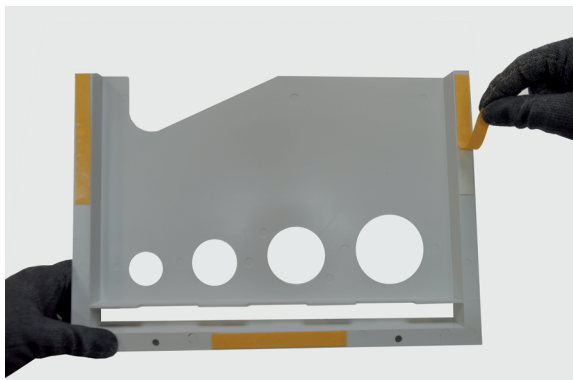

Cat.No 0 365 80/81:



Cat.No 0 365 82:



Cat.No 0 097 99:



## ENCLOSURES SHIPPING AND HANDLING

Enclosures' handling can be carried out using a lifting truck or lifting rings M12 (Cat.No 0 205 82).



Before any operation, for enclosures standing next to each other, secure the process using a coupling kit Cat.No 3 379 49 (mounting pages 14-15).

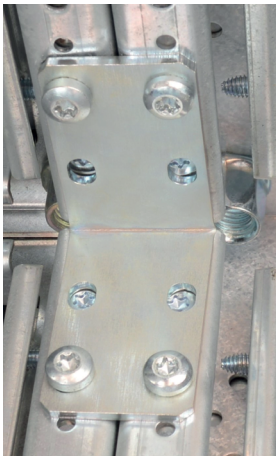

## Handling with a lifting truck



In this handling case, it is imperative to have envelopes equipped with juxtaposed bases.

It will be possible to take off the bases sides to enable the insertion of the lift truck forks. This type of handling requires an extreme caution regarding the enclosure not to fall. Suitable precautions should be taken.

## Handling by lifting

Lifting rings are usually used to lift enclosures to a width of less than 2m.

It is recommended to make sure the angle formed by cables is below 90°.

It is required to check if the maximum load (lift trucks+cables) is sufficient.

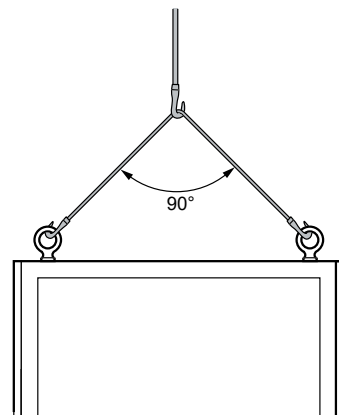

## Lifting enclosures with angle crosspieces

When units of width of more than 2 meters or when units contain heavy elements, handling operations can be done using angle crosspieces.

It is recommended to ensure cables and lifting machines are appropriate. Ensure the angle formed by cables is below 90°

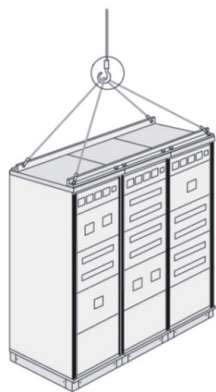

Enclosures already equipped are shipped "flat".  
Avoid stacking.



**Protect your enclosures once mounted and equipped using the reusable packaging.**

Enclosures can also be shipped in a vertical position, back-to-back, on a pallet, considering all the precautions needed (dunnage and strapping).

## WALL AND/OR FLOOR FIXING

### Fixing pitch tables

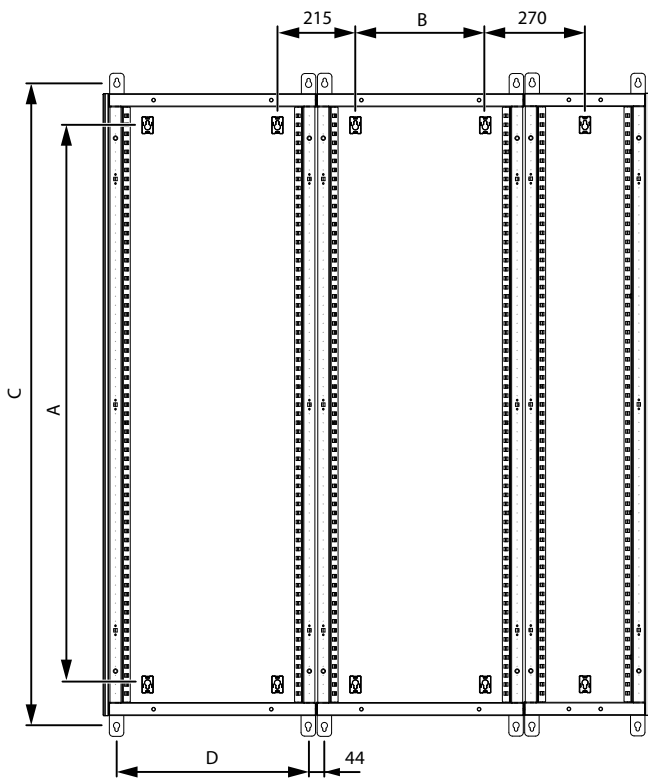

#### 24 MODULES ENCLOSURES

Cat.Nos	A (mm)	B (mm)	C (mm)	D (mm)
3 375 22	667	360	900	531
3 375 32	817	360	1050	531
3 375 42	967	360	1200	531
3 375 52	1117	360	1350	531
3 375 62	1267	360	1500	531
3 375 72	1417	360	1650	531
3 375 82	1567	360	1800	531
3 375 92	1717	360	1950	531
3 376 02	1867	360	1950	531
3 376 12	2017	360	2250	531
3 376 22	2167	360	2400	531

#### 36 MODULES ENCLOSURES

Cat.Nos	A (mm)	B (mm)	C (mm)	D (mm)
3 375 23	667	560	900	731
3 375 33	817	560	1050	731
3 375 43	967	560	1200	731
3 375 53	1117	560	1350	731
3 375 63	1267	560	1500	731
3 375 73	1417	560	1650	731
3 375 83	1567	560	1800	731
3 375 93	1717	560	1950	731
3 376 03	1867	560	1950	731
3 376 13	2017	560	2250	731
3 376 23	2167	560	2400	731

#### 16 MODULES ENCLOSURES

Cat.Nos	A (mm)	B (mm)	C (mm)	D (mm)
3 375 21	667	210	900	381
3 375 31	817	210	1050	381
3 375 41	967	210	1200	381
3 375 51	1117	210	1350	381
3 375 61	1267	210	1500	381
3 375 71	1417	210	1650	381
3 375 81	1567	210	1800	381
3 375 91	1717	210	1950	381
3 376 01	1867	210	1950	381
3 376 11	2017	210	2250	381
3 376 21	2167	210	2400	381

#### EXTERNAL CABLE SLEEVES

Cat.Nos	A (mm)	B (mm)	C (mm)	D (mm)
3 375 20	667	-	900	281
3 375 30	817	-	1050	281
3 375 40	967	-	1200	281
3 375 50	1117	-	1350	281
3 375 60	1267	-	1500	281
3 375 70	1417	-	1650	281
3 375 80	1567	-	1800	281
3 375 90	1717	-	1950	281
3 376 00	1867	-	1950	281
3 376 10	2017	-	2250	281
3 376 20	2167	-	2400	281

## ▪ Internal wall fixing

1. Cut the plastic shutters



2. Position the enclosure and note the position of dowels if needed (bulkhead or concrete bearing wall among others).
3. Fix the enclosure with screws of adapted diameter and length, tightening torque 8 N.m.

## ▪ External wall fixing (fixing brackets Cat.No 3 379 52)



1. Fix the 4 brackets on the enclosure with M12 head screws provided with the enclosure → 8mm hex key, tightening torque 8 N.m.



2. Position the enclosure and note the position of dowels if needed (bulkhead or concrete bearing wall among others).
3. Fix the enclosure with screws of adapted diameter and length, tightening torque 8 N.m.

## ▪ Floor fixing

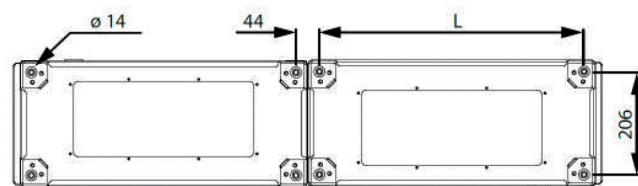

Width	L (mm)
Cable sleeves	281
16 modules	381
24 modules	531
36 modules	731

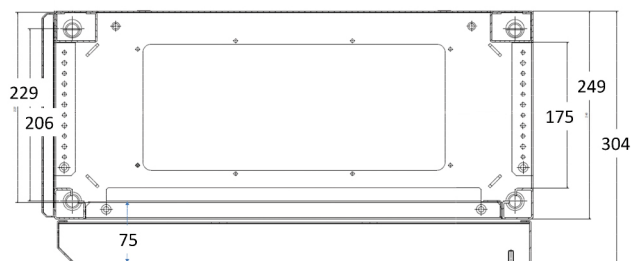









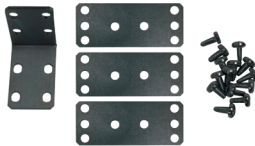

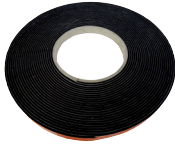

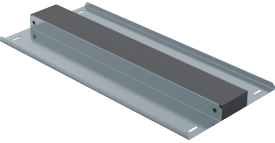
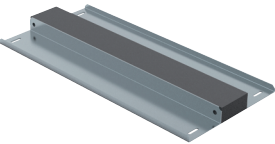
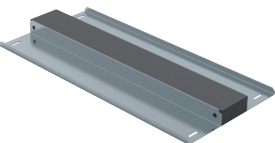
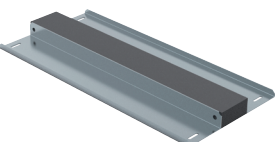

With the help of the illustration above, drill the floor, insert dowels, then position enclosures and fix them using the holes of the bases (Ø 14mm).







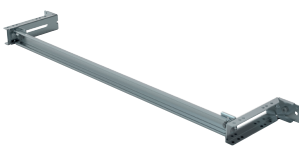
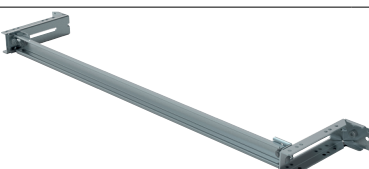

## SPARE PARTS & ACCESSORIES

XL<sup>3</sup> S enclosures have several registered spare parts and accessories.





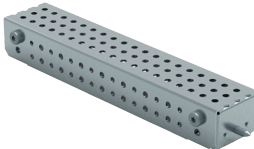
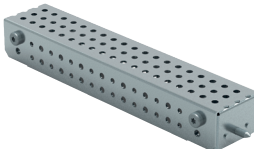

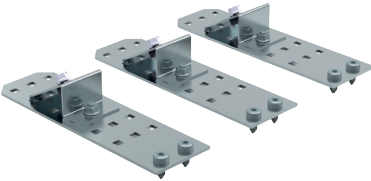

Cat.Nos	Description		Content
3 379 49	XL <sup>3</sup> S 630/4000 Coupling kits		1 link plate, 3 flat plates 16 auto-tapping screws
3 379 50	XL <sup>3</sup> S 630/4000 Coupling screws		8 screws 2 nuts 6 cage-nuts
3 379 51	Kit IP 43		1 roll (10 m)
3 379 52	XL <sup>3</sup> S 630 Wall fixing lugs		2 brackets
3 379 54	XL <sup>3</sup> S 630 Cable sleeve foam gasket cable entry plate		x1
3 379 55	XL <sup>3</sup> S 630 16 modules foam gasket cable entry plate		x1
3 379 56	XL <sup>3</sup> S 630 24 modules foam gasket cable entry plate		x1
3 379 57	XL <sup>3</sup> S 630 36 modules foam gasket cable entry plate		x1

Cat.Nos	Description		Content
3 382 20	DIN Rail 3 pos. 16 modules for XL <sup>3</sup> S		1 rail 2 rail brackets 2 fixing brackets 4 auto-tapping screws
3 382 23	DIN Rail 3 pos. 24 modules for XL <sup>3</sup> S		1 rail 2 rail brackets 2 fixing brackets 4 auto-tapping screws
3 382 26	DIN Rail 3 pos. 36 modules for XL <sup>3</sup> S		1 rail 2 rail brackets 2 fixing brackets 4 auto-tapping screws
3 382 40	Rail height spacer: DPX <sup>3</sup> + modular devices		x1
3 382 41	Rail height spacer: DRX + modular devices		x1
3 382 42	Rail height spacer: DPX <sup>3</sup> + DRX		x1
3 382 43	Universal rail 16 modules		1 rail 2 brackets 2 fixing brackets, 2 auto-tap. screws, 4 nuts 4 metric screws
3 382 44	Universal rail 24 modules		1 rail 2 brackets 2 fixing brackets, 2 auto-tap. screws, 4 nuts 4 metric screws
3 382 45	Universal rail 36 modules		1 rail 2 brackets 2 fixing brackets, 2 auto-tap. screws, 4 nuts 4 metric screws
3 397 02	100 screws for faceplate		100 screws 100 cage nuts 100 washers 25 earthing claws





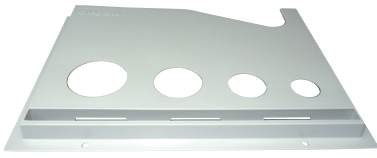



## SPARE PARTS & ACCESSORIES

Cat.Nos	Description		Content
3 397 11	Handle for XL <sup>3</sup> S 630 ≤ 1200mm		1 handle 1 clip
3 397 12	Handle for XL <sup>3</sup> S 630 ≥ 1350mm		1 handle 2 circlips 1 plastic cover
3 397 16	Handle for XL <sup>3</sup> S 630 type 405 ≤ 1200mm		1 handle 1 clip 2 keys
3 397 17	Handle for XL <sup>3</sup> S 630 type 405 ≥ 1350mm		1 handle 2 circlips 2 keys
3 397 21	Earth busbar support		2 supports 2 clips, 4 crosshead screws 2 metric screws
3 397 30	Crosspieces for external cable sleeves		2 crosspieces 4 fixing brackets 8 auto-tapping screws
3 397 31	Crosspieces for 16 modules enclosures		2 crosspieces 4 fixing brackets 8 auto-tapping screws
3 397 37	Crosspiece for internal cable sleeves		1 crosspieces 2 fixing brackets 4 auto-tapping screws 2 countersunk head screws
3 397 51	Universal support vertically sloped cable sleeves		3 perforated plates 3 sloped plates 3 screws dome heads 3 pipe-nuts 3 metric screws 6 auto-tapping screws 3 metric nuts



Cat.Nos	Description		Content
3 397 53	Equipotential bonding conductor		x1
3 397 54	Blanking plate 24 modules		x1
3 397 55	Self-adhesive label holder 24 modules		1 label holder 1 sheet of labels
3 397 56	Self-adhesive label holder 36 modules		1 label holder 1 sheet of labels
3 397 57	Brass bar 36 modules		x1
3 397 58	Duct fixing brackets		2 brackets 2 auto-tapping screws 3 dome head or metric screws 2 metric nuts 4 plastic rivets
0 205 82	Lifting rings M12		x4
0 365 80	Self-adhesive open doc. holder width. 340 x H 235 grey RAL 7035		x1
0 365 81	Self-adhesive open doc. holder width. 260 x H 165 grey RAL 7035		x1
0 365 82	Self-adhesive close doc. holder- IP 50 324 x 120 x 18mm grey RAL 7035		x1

## SPARE PARTS & ACCESSORIES

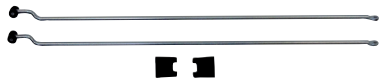
Cat.Nos	Description		Content
0 097 99	Flexible plastic cover 305 x 220mm - transparent		x1
0 016 60	Blanking plates 5 modules White RAL 9010		x1
0 373 01	Brassbar 24 modules		1 brass bar 24 modules 2 fixing brackets 2 cage-nuts 2 screws 2 lock washers 2 serrated washers 2 marking stickers
0 477 12	Nut clips for M6 screws		x 50
9 809 00	Self-tapping screw Torx S30		x 50
9 809 04	XL <sup>3</sup> S 630/4000 door hinge		1 hinge 1 axle 1 M6 screw 1 cage-nut
9 809 06	Linking system doors H1350mm		2 links H 1350mm 2 brackets
9 809 07	Linking system doors H 1500mm (with brackets)		2 links H 1500mm 2 brackets
9 809 08	Linking system doors H 1650mm (with brackets)		2 links H 1650mm and 2 brackets

Cat.Nos	Description		Content
9 809 09	Linking system doors H 1800mm (with brackets)		2 links H 1800mm and 2 brackets
9 809 10	Linking system doors H 1950mm (with brackets)		2 links H 1950mm and 2 brackets
9 809 11	Linking system doors H 2100mm (with brackets)		2 links H 2100mm and 2 brackets
9 809 12	Linking system doors H 2250mm (with brackets)		2 links H 2250mm and 2 brackets
9 809 15	Locking system link for XL <sup>3</sup> S 630		Locking system link H 55mm, 2 rings and 1 locking screw
9 809 17	Door locking hook for XL <sup>3</sup> S 630		1 locking hook 1 M6 screw + 1 cage-nut
9 809 20	Cage-nuts		x 50



## World Headquarters and International Department

87045 Limoges Cedex -  
France  
Tel: +33(0)5 55 06 87 87

---

### FOLLOW US ON

---

- @ legrand.com
- ▶ youtube.com/user/legrand
- ✕ x.com/Legrand
- in linkedin.com/company/legrand

