



















Metselwerk	2 modules  502E (70x70x50 mm)	3 modules  503E (108x74x53.5 mm)	4 modules  504E (133x74x53.5 mm)	6 modules  506L (183.5x90x53.5 mm)
Holle wanden	 PB502N (Ø 71x50.5 mm)	 PB503N (110x71x52 mm)	 PB504N (132.5x71x52 mm)	 PB506N (183x71x52 mm)
Houders	 K4702 (*)	 K4703 met schroeven	 K4704 met schroeven	 K4706 met schroeven
Aantal modules (functies)	 2 modules	 3 modules	 4 modules	 6 modules
Afwerking afdekplaten	 KA4802...	 KA4803...	 KA4804...	 KA4806...
Aantal toetsen van 1 module nodig om de installatie te voltooien	 2 toetsen	 3 toetsen	 4 toetsen	 6 toetsen

* **Opmerking:** Geleverd zonder schroeven. Gebruik de bij de 502E en PB502N dozen meegeleverde schroeven.

BEVEILIGDE INSTALLATIES

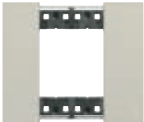

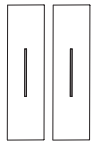
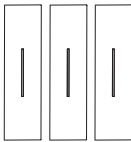
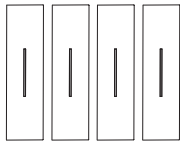
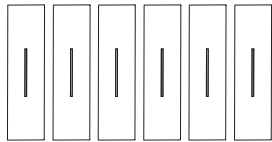
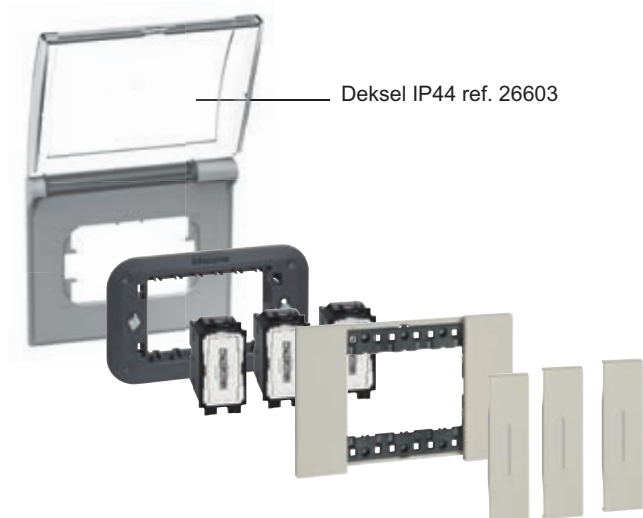
Opmerking: bijgeleverde beschermkap voor alle modulehouders (2, 3, 4 en 6 modules).

Te gebruiken:

- op de werf vóór de installatie van de afdekplaten en toetsen
- na verwijdering van de afdekplaten, sierplaten en/of toetsen in geval van schilderwerken