

Stroomtransformatoren (CT)

technische kenmerken (zie blz. 509)

■ Afmetingen

Gesloten stroomtransformatoren

Ref. 412101/02/03/04/05/06/07



Ref. 412112/14

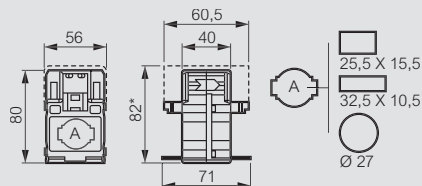

Ref. 412116/17/19

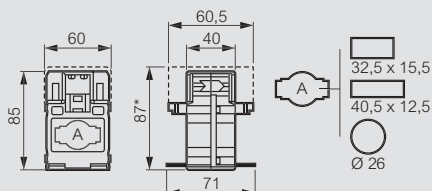

Ref. 412123/24/25/26

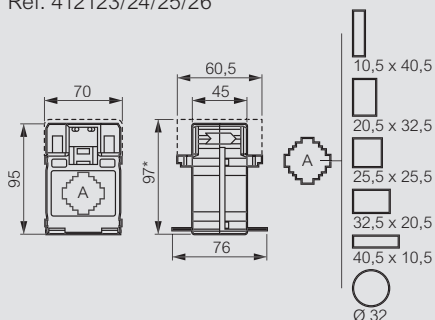

Ref. 412131/32/33

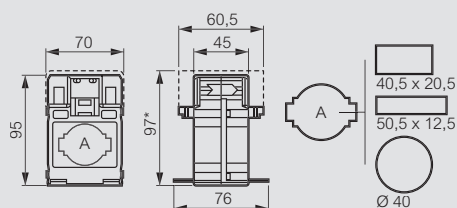

Ref. 412136/38/39/42/46/47/49/50/51/52/53/54

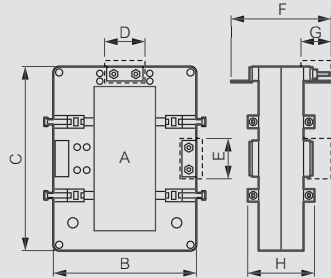

Ref.	A	B	C	D	E	F	G	H
412136/38/39	32 x 65	90	94	33,5	33,5	90	25	40
412142	34 x 84	96	116	33,5	33,5	87	25	40
412146/47/49	38 x 127	99	160	33,5	33,5	87	25	58
4 12150/51/52/53/54	54 x 127	125	160	33,5	33,5	87	25	40

Open stroomtransformatoren

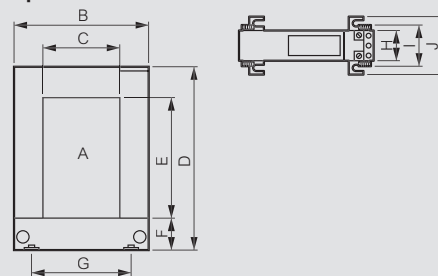

Ref.	A	B	C	D	E	F	G	H	I	J
412162/63	50 x 80	114	50	145	80	33	78	32	46	69
412164/65	80 x 120	144	80	185	121	32	108	32	46	69
412166/67/68/69	80 x 160	184	80	245	160	38	120	32	46	69

Driefasige stroomtransformatoren

Ref. 412157 voor 3 staven 20,5 x 5,5 mm

Ref. 412158 voor 3 staven 30,5 x 5,5 mm

Bevestiging op staaf

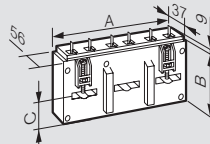

Ref.	A	B	C
412157	107	58,5	25
412158	135	66,5	30

■ Bepaling van de maximale kabelengte tussen stroomtransformatoren (CT) en meettoestellen

Kaliber (A)	Ref.	Max. vermogen CT		Max. kabelengte tussen CT/ meettoestel (m)		
		Klasse 0,5 (VA)	Klasse 1 (VA)	Kabel 1,5mm ²	Kabel 2,5mm ²	Kabel 6mm ²
50	412101		1,25	1,1	1,8	4,4
75	412102		1,5	1,5	2,4	5,9
100	412103	2		2,2	3,7	8,9
125	412104	2,5		2,9	4,9	11,8
160	412105	3		3,7	6,1	14,8
200	412106	4		5,1	8,5	20,7
250	412107	5		6,6	11,0	26,6
400	412112	10		13,9	23,2	56,2
600	412114	12		16,8	28,1	68,1
250	412116	3		3,7	6,1	14,8
400	412117	6		8,0	13,4	32,6
700	412119	8		11,0	18,3	44,4
250	412123	3		3,7	6,1	14,8
300	412124	5		6,6	11,0	26,6
400	412125	8		11,0	18,3	44,4
600	412126	12		16,8	28,1	68,1
700	412131	8		11,0	18,3	44,4
800	412132	8		11,0	18,3	44,4
1000	412133	10		13,9	23,2	56,2
600	412136	8		11,0	18,3	44,4
800	412138	12		16,8	28,1	68,1
1000	412139	15		21,2	35,4	85,8
1250	412142	12		16,8	28,1	68,1
1600	412146	10		13,9	23,2	56,2
2000	412 147	15		21,2	35,4	85,8
3200	412149	25		35,8	59,8	145,0
1600	412150	20		28,5	47,6	115,4
2000	412151	25		35,8	59,8	145,0
2500	412152	30		43,1	72,0	174,6
3200	412153	30		43,1	72,0	174,6
4000	412154	30		43,1	72,0	174,6
3 X 250	412157		3	3,7	6,1	14,8
3 X 400	412158		4	5,1	8,5	20,7
400	412162	1,5		1,5	2,4	5,9
750	412163	3		3,7	6,1	14,8
1000	412164	5		6,6	11,0	26,6
1500	412165	8		11,0	18,3	44,4
2000	412166	15		21,2	35,4	85,8
2500	412167	15		21,2	35,4	85,8
3000	412168	20		28,5	47,6	115,4
4000	412169	20		28,5	47,6	115,4