

L'APPAREILLAGE

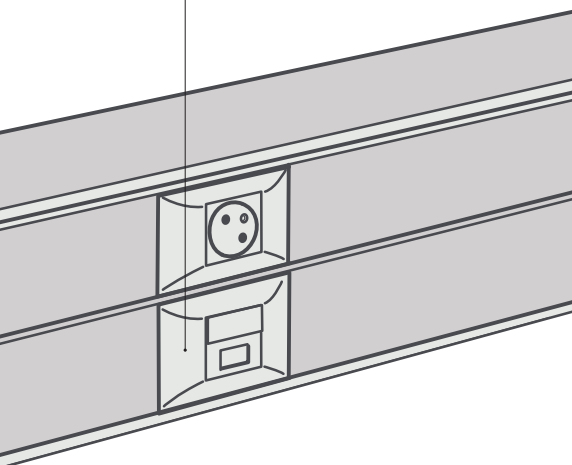





La goulotte reçoit tout type d'appareillage et d'équipement

Plus de 200 fonctions Mosaic qui s'adaptent à la goulotte



Goulottes DLP design

Les goulottes DLP design permettent de concevoir des installations parfaitement modulables dans le temps. Avec les goulottes DLP design, vous disposez de solutions adaptées à chacun de vos chantiers

Section (mm)	Réf.	
35 x 80	010461	
35 x 105	010463	
50 x 80	010462	
50 x 105	010424	
	010464	
50 x 150	010465	
	010432	
	010427	
50 x 170	010467	
50 x 220	010428	
65 x 150	010475	
	010433	
65 x 195	010476	
	010453	
65 x 220	010459	

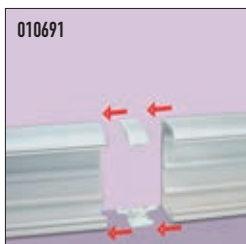

010691 Joint de corps à éclisse, se monte pendant l'installation des goulottes. Permet d'aligner les 2 corps et d'avoir une finition parfaite

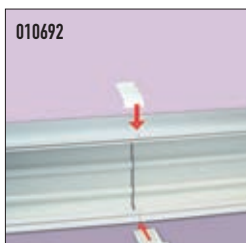

010692 Joint de corps, fixation par adhésif (pose en fin d'installation)