

CHARTRES AV PC

CHARTRES AV PC -

DÉTECTION

ROND

POLYCARBONATE - POLYCARBONATE

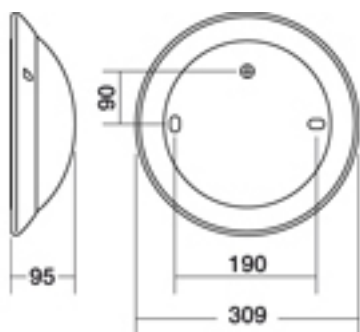

Référence du produit : 714570







Classe : 

ÉLÉMENTS NORMATIFS

IP55 IK10  CLASSE II 960 °C/5 sec.  
 NF EN 60695-2-1

SOURCE

► Détecteur intégré (HF)

 E27 75W	 E27 53W
 E27 70W	 G24q2 18W
 G24q3 26W	 GX24q3 32W

COULEUR

 Blanc

CARACTÉRISTIQUES TECHNIQUES

Hublot rond Ø 309 mm. Classe II. IP 55, IK10. Version antivandale et Détecteur intégré (HF). Source incandescente 60W - douille E27 en porcelaine. Jupe et diffuseur en Polycarbonate. Inserts en laiton.

FACILITÉ DE POSE ET DE MAINTENANCE

Chartres simplifie mise en oeuvre et entretien : réglage de niveau, connexion automatique, vis imperdable, diffuseur maintenu par clips, réserve de câble.