

CHARTRES PC-VERRE

CHARTRES - DÉTECTION

ROND

POLYCARBONATE - VERRE ÉMAILLÉ

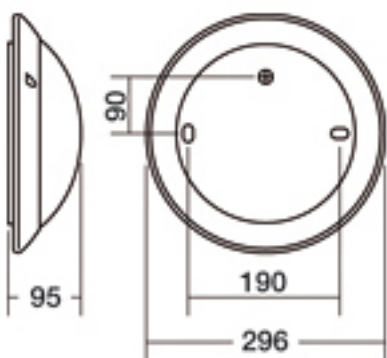

Référence du produit : 514570







Classe : 

ÉLÉMENTS NORMATIFS

IP54 IK04 CLASSE II 960 °C/5 sec. 
 NF EN 60695-2-1

SOURCE

► Détecteur intégré (HF)

 E27 53W-20W	 E27 53W
 E27 70W-23W	 G24q2 18W
 G24q3 26W	 GX24q3 32W

COULEUR

 Blanc

AIDE AUX DESCRIPTIFS

Livré sans lampe

CARACTÉRISTIQUES TECHNIQUES

Hublot rond Ø 296 mm. Version Détecteur intégré (HF). Classe II. IP 54, IK04. Douille E27 en porcelaine Maxi : 53W halogène, 15W CFLI. Jupe en Polycarbonate. Diffuseur en verre émaillé. Inserts en laiton.

FACILITÉ DE POSE ET DE MAINTENANCE

Chartres simplifie mise en oeuvre et entretien : réglage de niveau, connexion automatique, vis imperdable, diffuseur maintenu par clips, réserve de câble.