

Ø 532

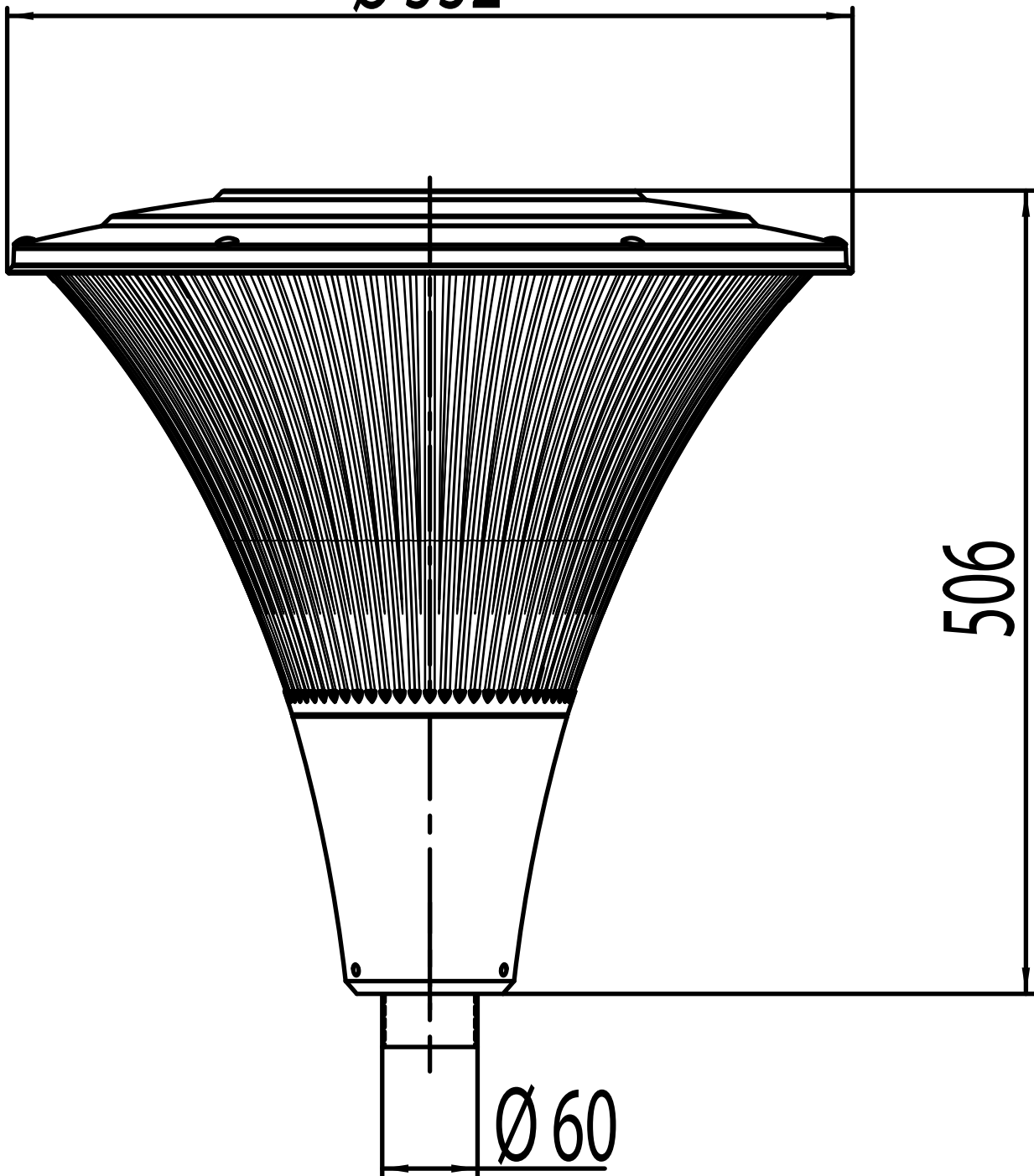

506

Ø 60