

ID	Description	Date	By	Appr.
A				

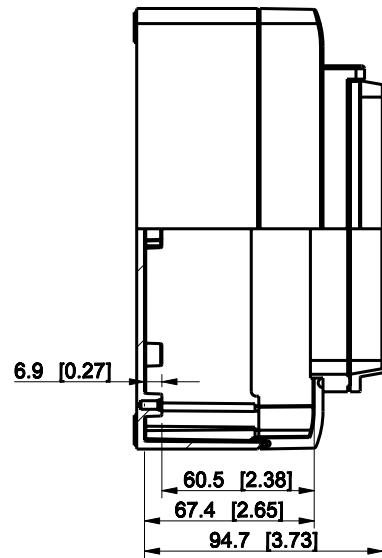
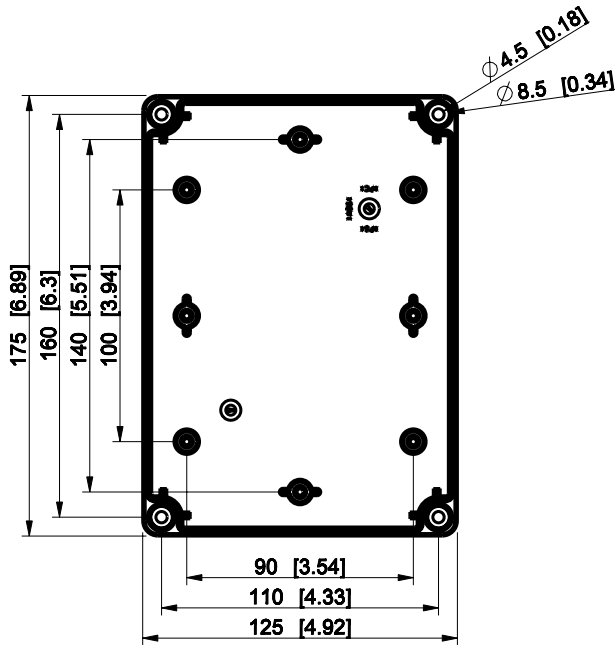
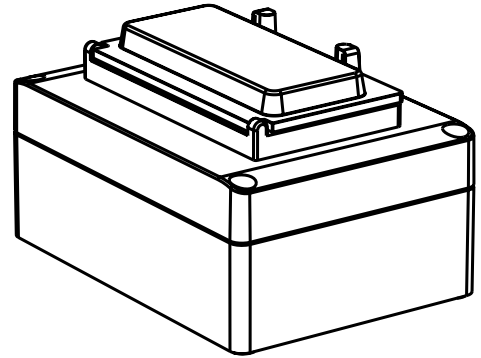
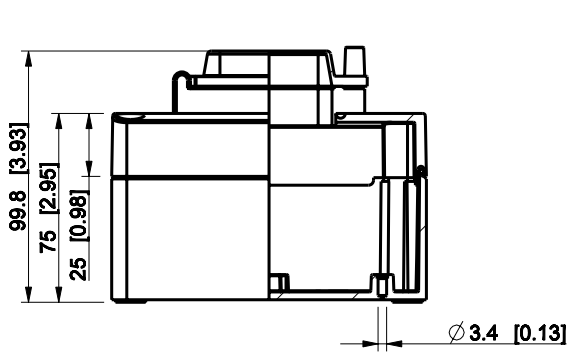

Dimensions in mm [inches]

model RABP131808G_6M PART drawing CUBOR_1_1.DRAWING	Material: ABS		Color: RAL 7035	
	Supplier: ENSTO		Tool No:	
	Scale: 1:3		Weight [kg]: 8.97	
	Date: 13.03.09		Volume:	
	By: PKos		Replaces:	
Checked:		Replaced:		
Ctrl:		Drw No: A		
		Ref: Cubo R		
		Code: RABP131808G_6M		
		Sheet No:		

RABP131808G_6M