

Model: NGRW405020-U_NFL1.dwg
 Drawing: NGRW405020-U_NFL1.dwg
 Tolerance ISO 2768-m
 >0,5 =3 ±0,1
 >6 =6 ±0,1
 >6 =30 ±0,2
 >30 =120 ±0,3
 >120 =400 ±0,5
 >400 =1000 ±0,8

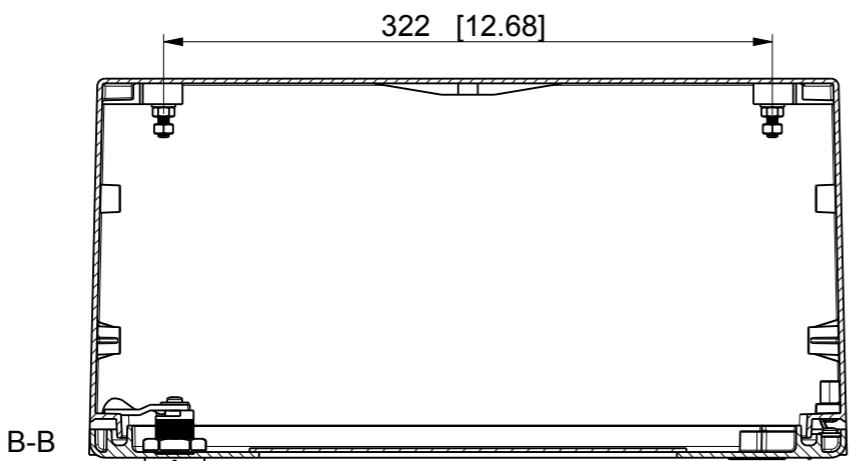

ID	Description	Date	By	Appr.
A				

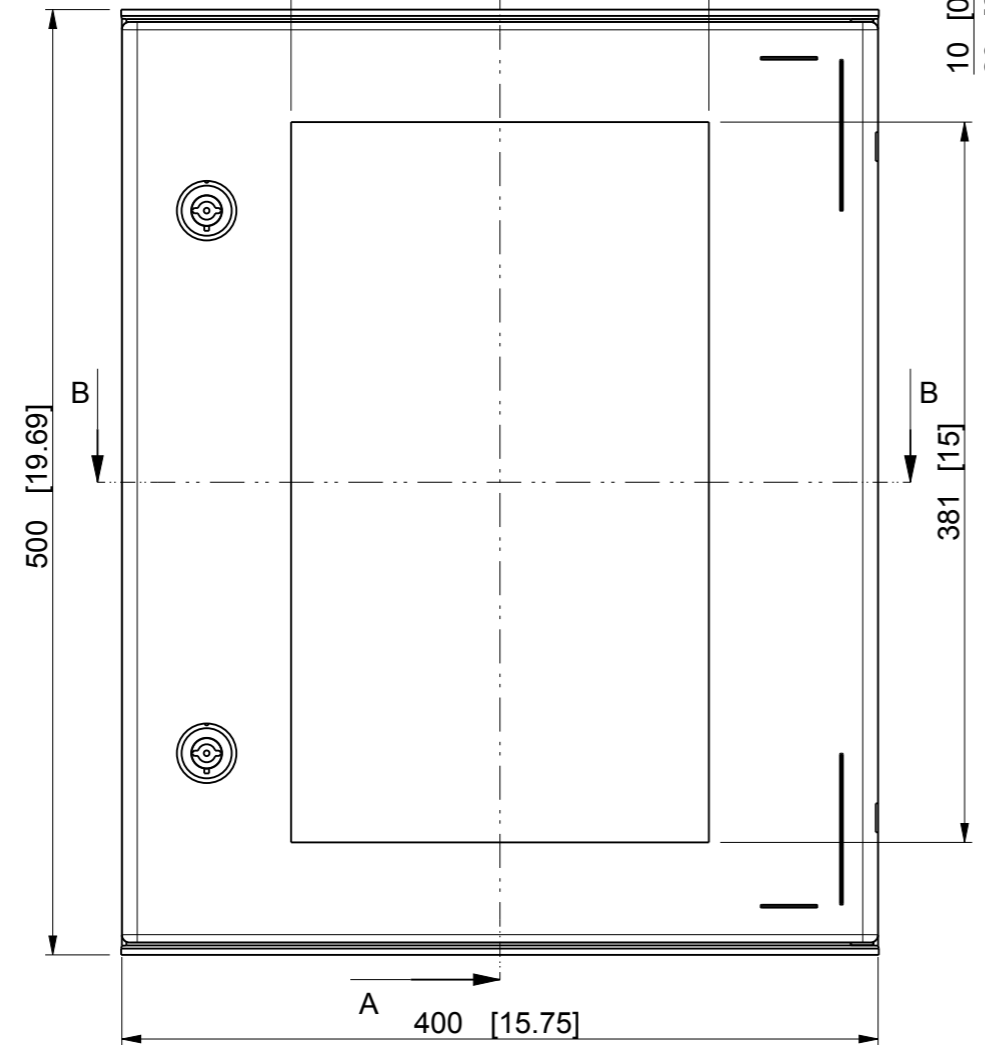
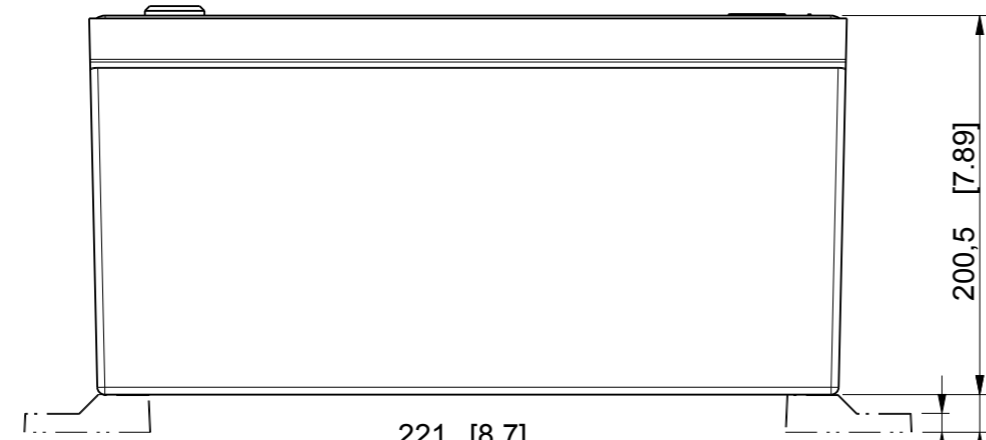
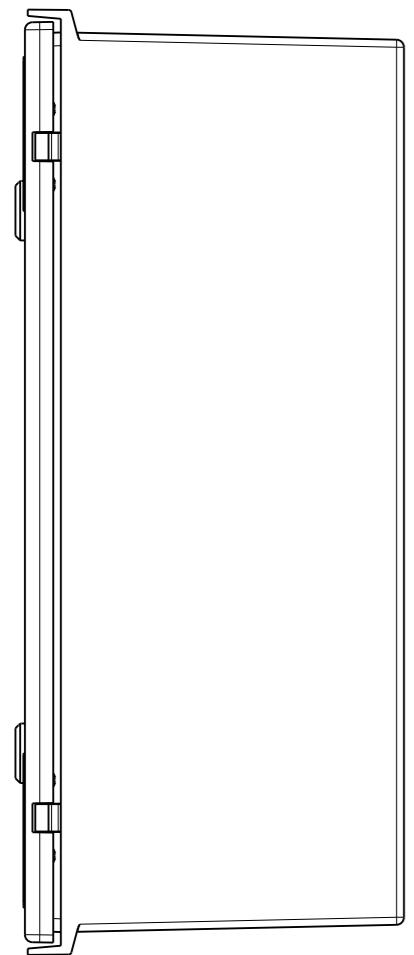
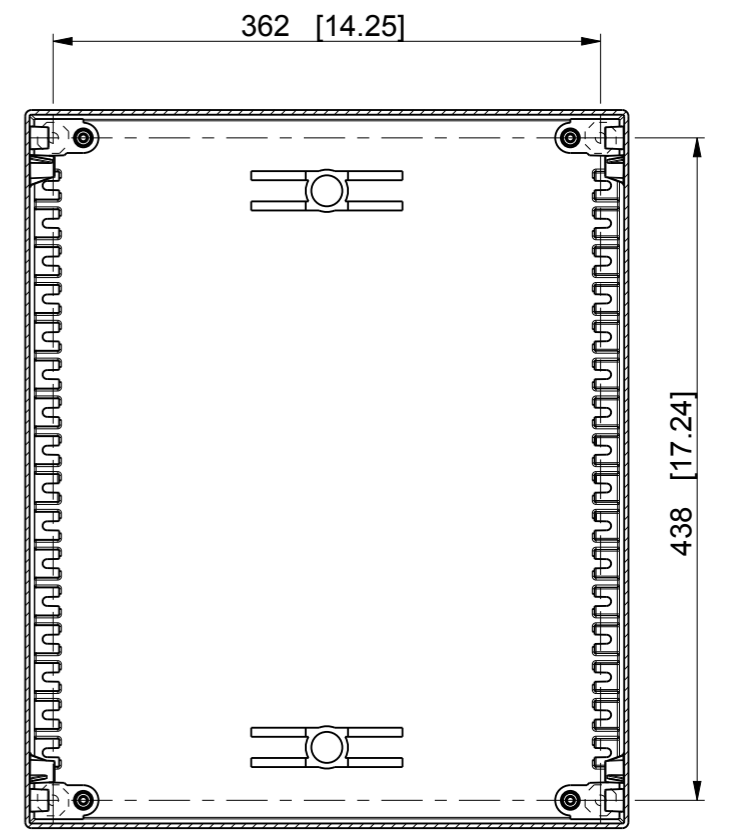
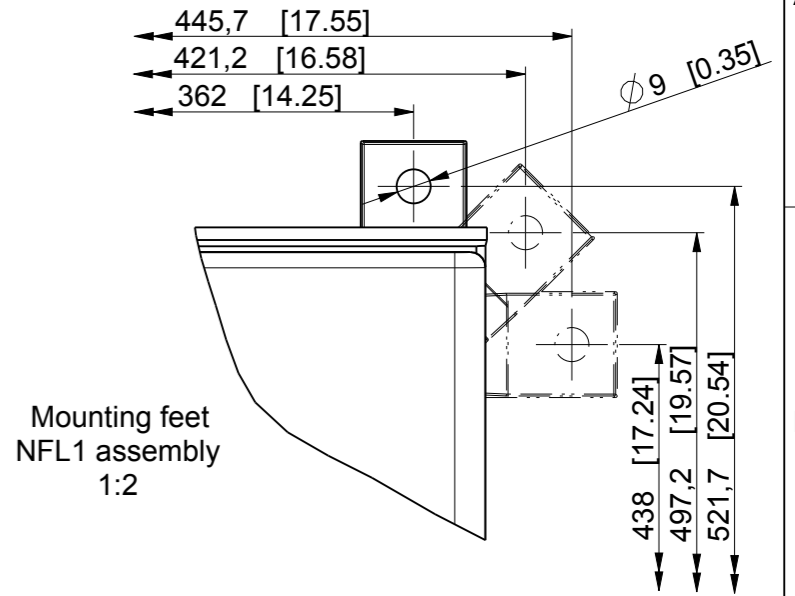
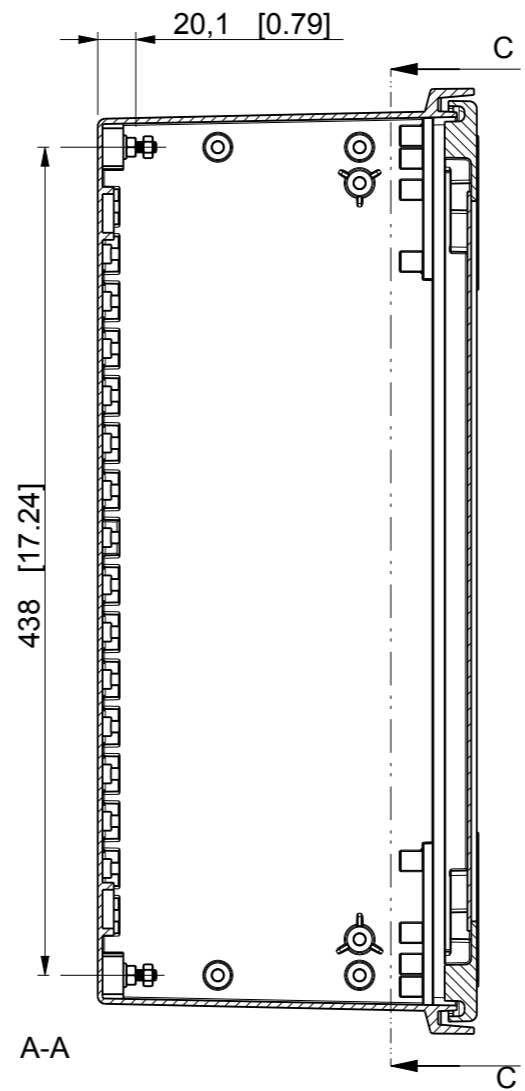

Dimensions in mm [inches]

Supplier: -	Tool No: -	Volume: -	Weight [g]: 0
Material: Glass reinforced polyester		Ensto Mat:	
 Ensto Finland Oy Ensto Electrification		NGRW405020.U UI 508A Industrial panel enclosure	
Scale: 1:4	Date: 25.11.2016	Replaces:	
A3	By: KA	Replaced:	
Sheet No: 1 (1)	Checked:	Drw No:	A
	Ctrl:	Ref:	Cubo N
		Code:	NGRW405020.U