

ID	Description	Date	By	Appr.
A				

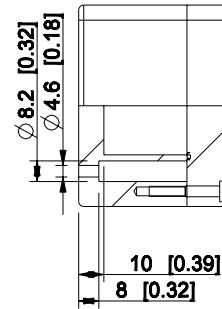
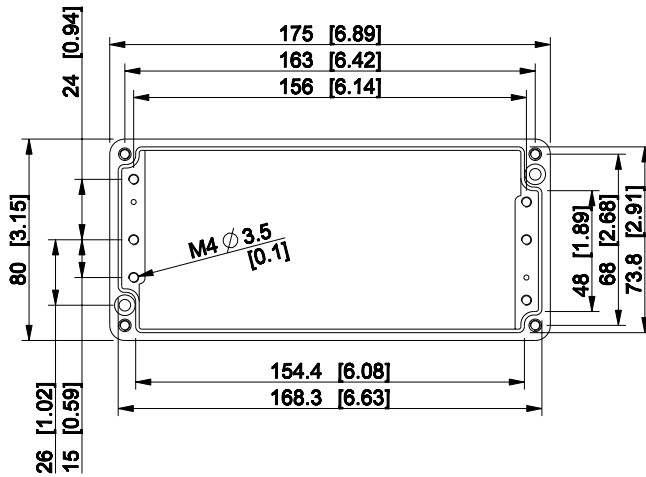
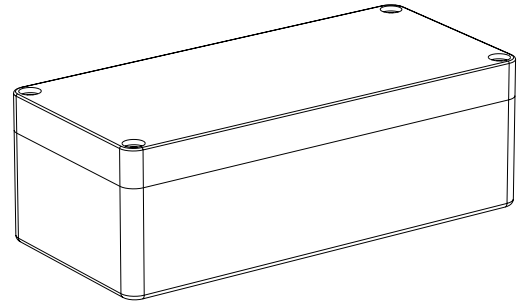
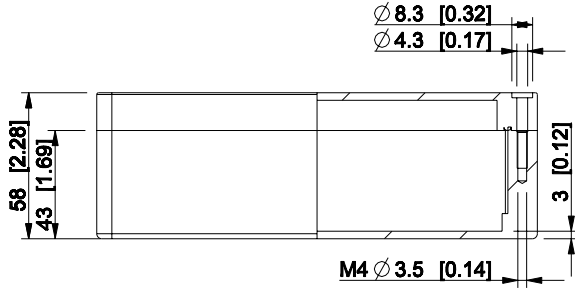

Dimensions in mm [inches]

Material: Aluminium	Color: RAL 7001
---------------------	-----------------

Supplier:	Tool No:	Weight [kg]: 0.85	Volume:
-----------	----------	-------------------	---------

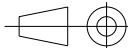

HALP081806

Scale	Date	27.04.09
1:3	By	TJMa
-	Checked	
-	Ctrl	

Replaces:	
Replaced:	
Drw No:	A
Ref:	Cubo H
Code:	HALP081806
Sheet No:	

model HALP081806 PART

drawing CUBO_H_8.DRAWING