

ID	Description	Date	By	Appr.
A				

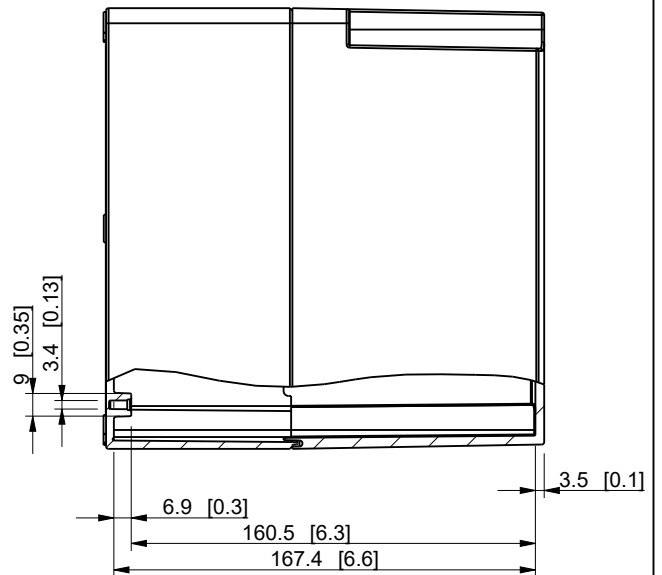
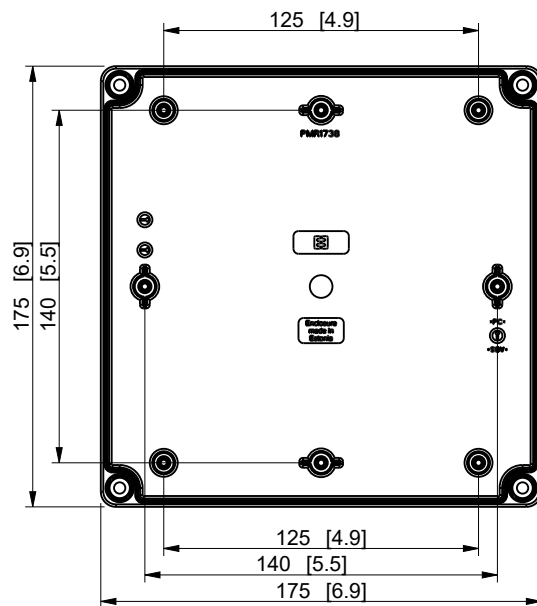
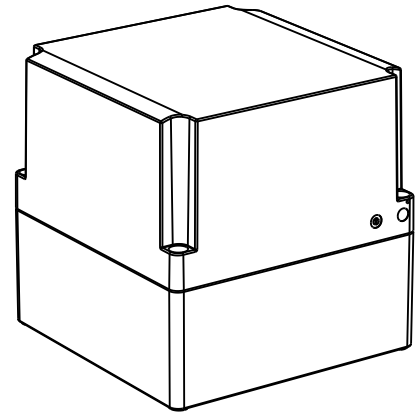
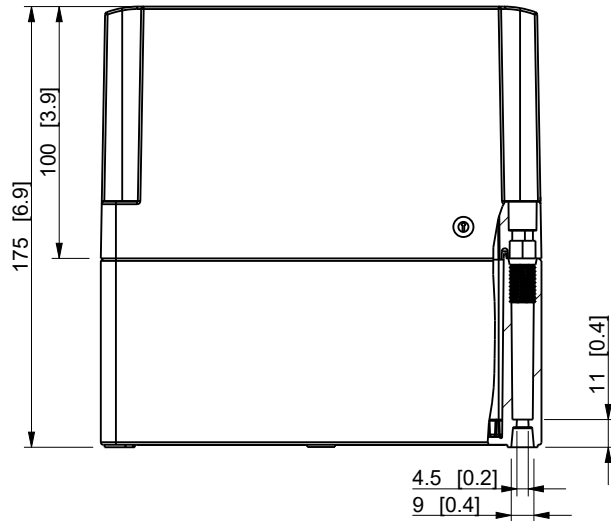

Dimensions in mm [inches]

Material: ABS	Color: RAL 7035
---------------	-----------------

Supplier: -	Tool No: -	Weight [kg]: 0.72	Volume: -
-------------	------------	-------------------	-----------

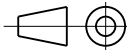

SABP181818HG

Scale	Date	28.09.20
1:3	By	PKos
-	Checked	
-	Ctrl	

Replaces:	
Replaced:	
Drw No: -	A
Ref:	Cubo S
Code:	SABP181818HG
Sheet No:	

model SABP181818HG PART
 drawing SABP181818HG PK1 DRAWING