

Emetteur ON/OFF pour interrupteur et poussoir (élément périphérique)

0 676 94



Ce produit est un accessoire connecté qui **nécessite** au préalable l'achat et l'installation du pack de démarrage et de prises, d'interrupteurs et/ou de micromodules d'éclairage connectés "... with Netatmo".



Ce produit ne commande que des interrupteurs, des micromodules d'éclairage, des sorties de câble et des prises connectés "... with Netatmo".

Composition du pack :

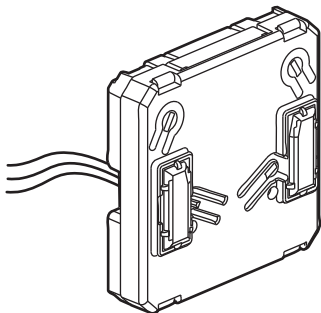

Emetteur ON/OFF
pour interrupteur et poussoir.
(Pile incluse)

Bande de fréquences : 2,4 à 2,4835 Ghz

Niveau de puissance : < 100 mW



www.legrand.fr/referance/067694

LEGRAND - Pro and Consumer Service - BP 30076
87002 LIMOGES CEDEX FRANCE • www.legrand.com

1 Précautions impératives de sécurité

1



Coupez le courant au disjoncteur général
OFF

2



Vérifiez l'absence de tension avant de procéder à l'installation.

2 Démontez l'interrupteur existant

Utilisez un **connecteur** (Nylbloc*) pour raccorder ensemble les 3 fils (navettes 1, 2 et celui du retour de lampe).

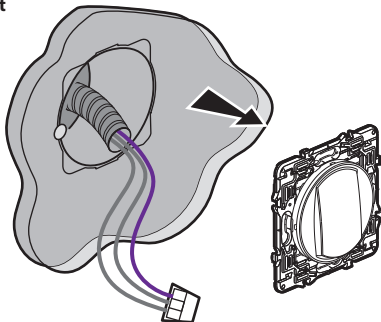

*non fourni



Ne pas alimenter sur le secteur
Contact sec uniquement

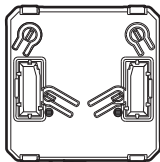

3 Précautions d'installation

L'émetteur ON/OFF ne peut contrôler qu'un seul produit filaire connecté (micromodule ou interrupteur ou prise ou sortie de câbles).

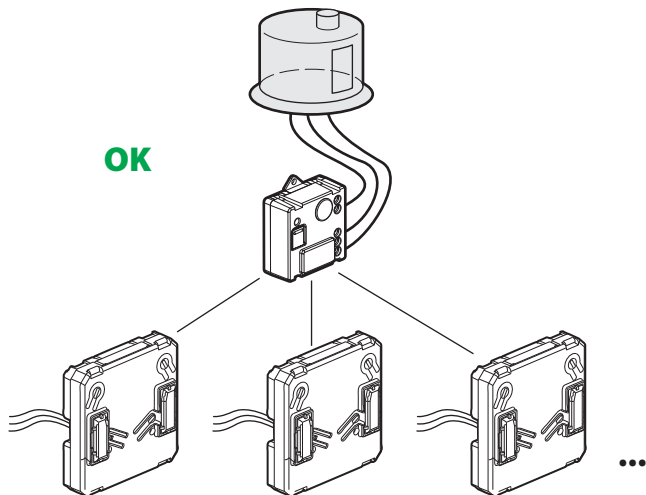

NOT OK

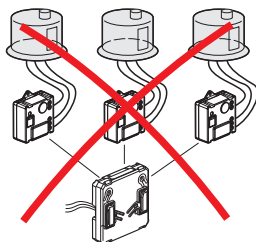

4 Démarrez la configuration des produits installés

1



Rétablissez le courant au disjoncteur général.

ON

- 2 Appuyez au centre de la **commande générale départ/arrivée** de la **prise Control** jusqu'à ce que le voyant de celle-ci s'allume brièvement en vert, puis relâchez l'appui.

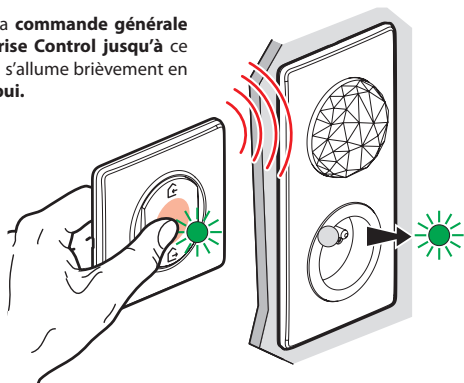

- 3 Les voyants des produits que vous avez câblés passent, les uns après les autres, en vert fixe.

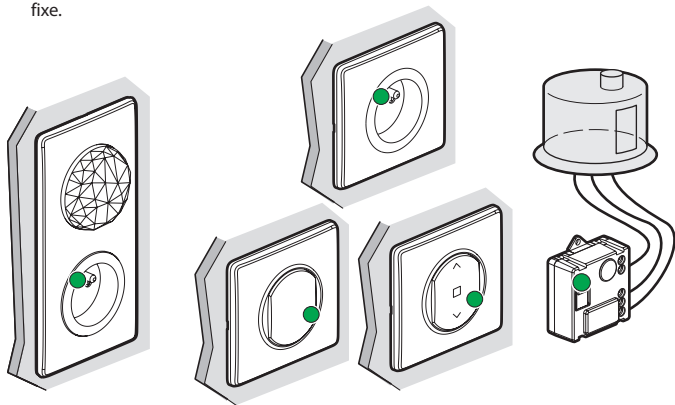

5 Préparez l'émetteur ON/OFF

1

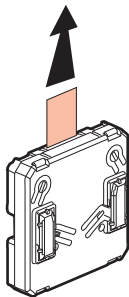

Retirez la languette de protection de l'émetteur

2

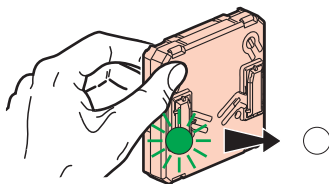

Appuyez **brèvement** sur l'émetteur afin de l'activer, son voyant clignote en vert puis s'éteint.

6 Associez l'émetteur ON/OFF à un produit filaire connecté



Assurez-vous que le voyant du produit filaire soit toujours vert fixe.
Si non, recommencez l'étape ④.

1 Comment associer l'émetteur ON/OFF à un produit filaire connecté ?

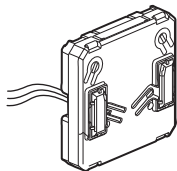

L'émetteur ON/OFF ne peut contrôler qu'un seul produit filaire connecté (micromodule ou interrupteur ou prise ou sortie de câble).

2 Pour associer un émetteur ON/OFF à un micromodule d'éclairage connecté

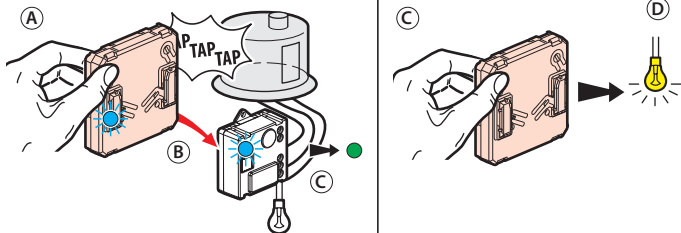

- ① Maintenez appuyé votre doigt sur le bouton de l'émetteur ON/OFF en tapotant avec celui-ci sur le micromodule que vous souhaitez commander.
- ② Les voyants des deux produits clignotent rapidement en bleu.
- ③ Les voyants des deux produits s'allument brièvement en bleu fixe, puis le voyant du produit câblé redevient vert, celui de l'émetteur s'éteint. L'association est réussie.
- ④ Vérifiez que la lumière s'allume.

7 Câblez l'émetteur ON/OFF

Mode interrupteur

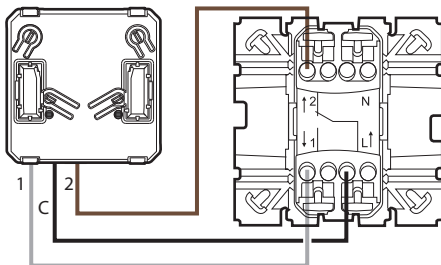
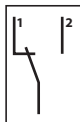

Mode poussoir

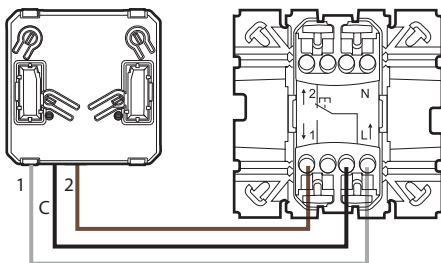
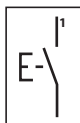

8 Remontez l'interrupteur existant

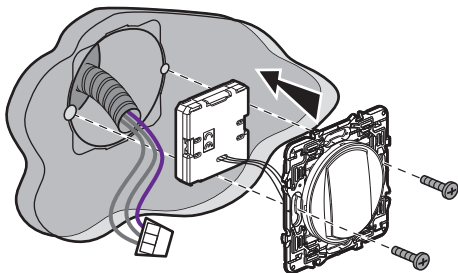

9 Pour associer l'émetteur ON/OFF à votre installation connectée, il est recommandé de suivre les instructions :

- depuis l'application **Legrand Home + Control** (section **Paramètres/Ajout de nouveau produit**)
- ou consulter les guides et notices d'utilisation sur **legrand.fr**

Remplacement de la pile

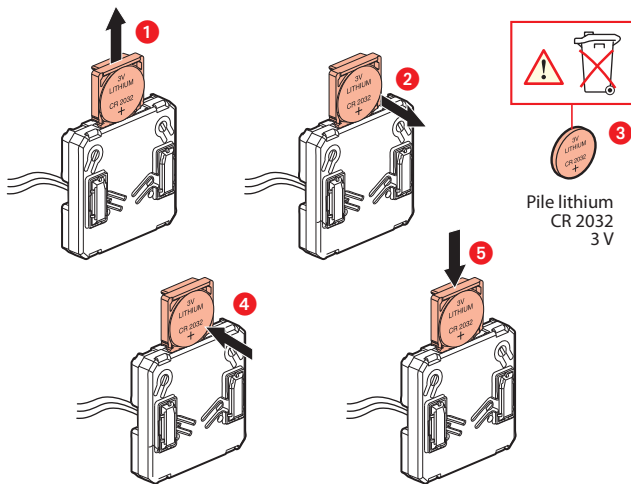

DÉCLARATION UE DE CONFORMITÉ SIMPLIFIÉE

Le soussigné,

Legrand

déclare que les équipements radioélectriques cités sur cette notice sont conformes à la directive 2014/53/UE.

Le texte complet de la déclaration UE de conformité est disponible à l'adresse internet suivante :

www.legrandoc.com

ON/OFF wireless light switch and push-button module

(peripheral)

0 676 94



This product is a connected accessory which requires you to buy and install the "...with Netatmo" connected starter pack and connected power outlets, switches and/or connected lighting micromodules first.



This product controls only "... with Netatmo" connected switches (with dimmer option), lighting micromodules, power outlets and cable outlets.

Pack contents:

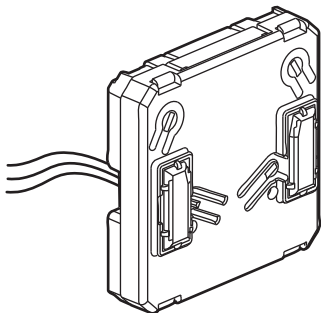

ON/OFF wireless light switch and push-button module (battery included)

Frequency bands : 2,4 - 2,4835 Ghz

Power level : < 100 mW



www.legrand.fr/reference/067694

LEGRAND - Pro and Consumer Service - BP 30076
87002 LIMOGES CEDEX FRANCE • www.legrand.com

1 Necessary safety precautions

1



Switch off the power at the main circuit breaker
OFF

2



Make sure that the power is **OFF** before continuing with the installation.

2 Remove the existing switch

Use a **connector** (Nylbloc*) to connect all 3 wires together (travellers 1 and 2 and lamp return wire).

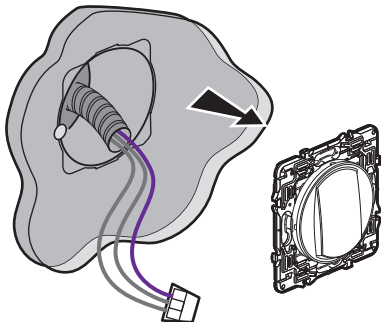

*not supplied



Do not power the product.
Dry contact only.

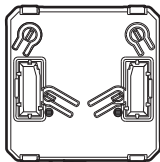

3 Install the ON/OFF wireless light switch

The ON/OFF transmitter can only control one wired connected product (micromodule or switch or plug or cable outlet).

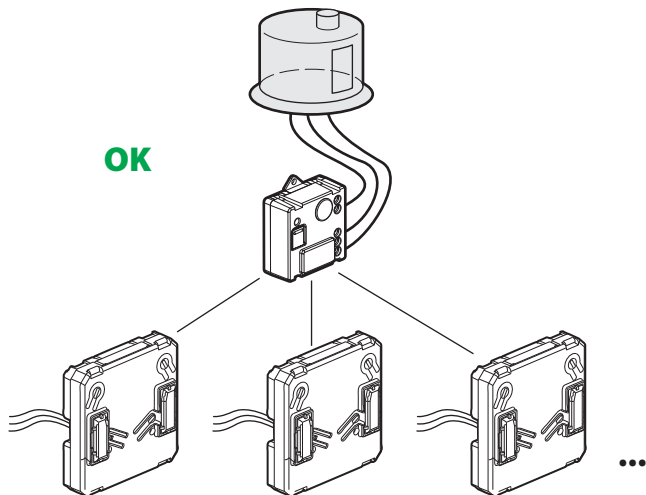

NOT OK

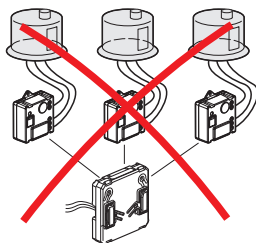

4 Start to configure the installed products

1



Turn the power back ON at the main circuit breaker.

ON

- 2 Press the middle of the Home/Away **wireless switch** until its light briefly turns green, and then stop pressing.

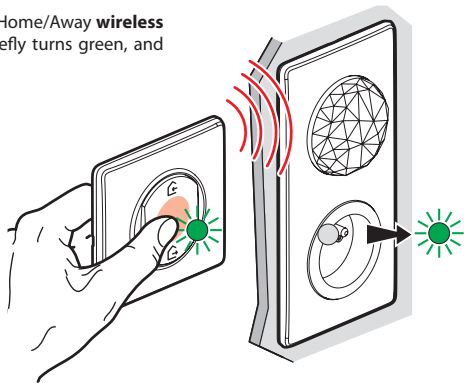

- 3 The indicator lights on the products which you have wired will turn green one by one.

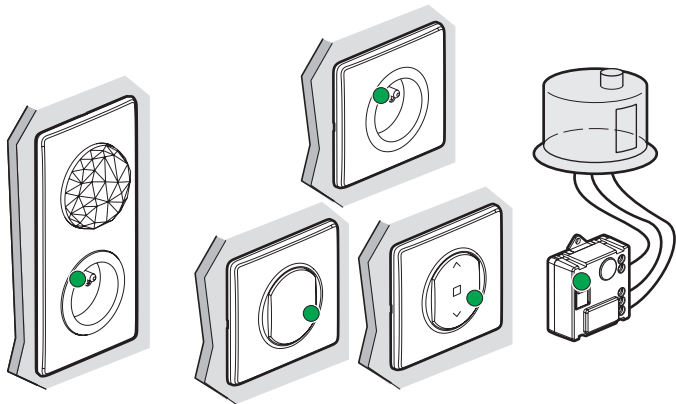

5 Prepare the ON/OFF wireless light switch

1

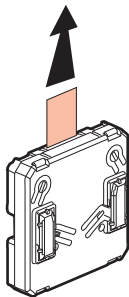

Remove the battery's protective strip to power the ON/OFF wireless switch

2

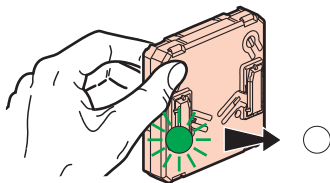

Briefly press on a button of the transmitter to activate it.
The indicator lights will flash green and then switch off.

6 Pair the ON/OFF transmitter with a connected wired product



Make sure that the indicator light on the wired product is green and not flashing. If not, go back to step ④.

1 How to pair a ON/OFF transmitter to a connected wired product ?

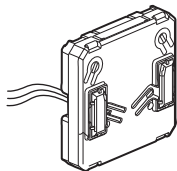

The ON/OFF transmitter can only control one wired connected product (micromodule or switch or plug or cable outlet).

2 To pair a ON/OFF transmitter with a connected lighting micromodule

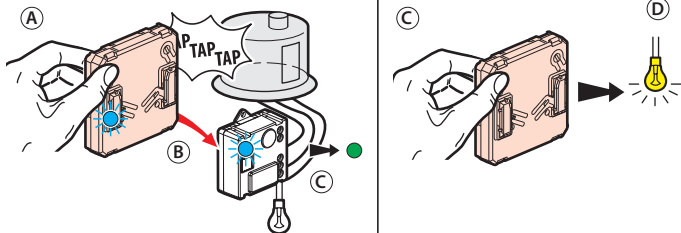

- ① Press on the ON/OFF transmitter you wish to pair, with taping it three times onto the micromodule you wish to control.
- ② The indicator lights on the two products will flash blue rapidly.
- ③ The indicator lights on the two products will briefly turn blue and not flash, and then the light on the wired product will turn green again and the light on the ON/OFF transmitter will switch OFF. The pairing was successful.
- ④ Check that the light comes ON.

7 Wire the ON/OFF transmitter

Switch mode

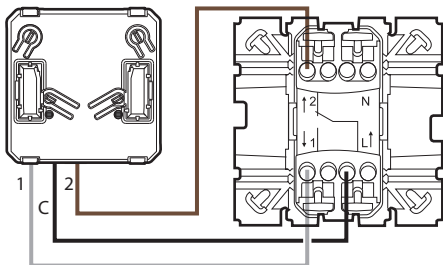
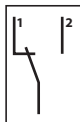

Push mode

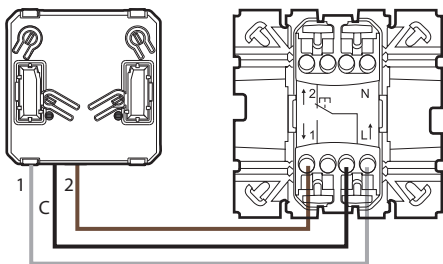
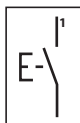

8 Replace the existing switch

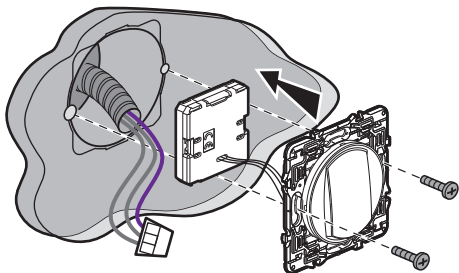

9 To add the ON/OFF transmitter to your connected installation, you should follow the instructions:

- in the **Legrand Home + Control (Settings/Add a new product section)**
- ou consult the guides and instructions use on **legrand.fr**

Replacing the battery

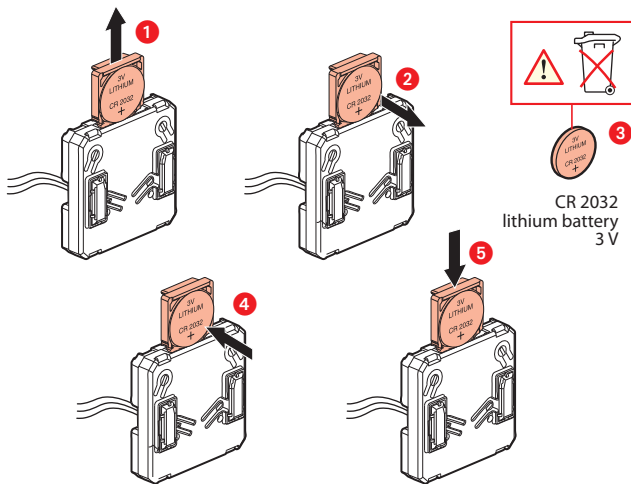

SIMPLIFIED EU DECLARATION OF CONFORMITY

The undersigned,

Legrand

declares that the radio-electric equipment referred to in these instructions complies with directive 2014/53/EU.

The full text of the EU declaration of conformity is available on the following website:

www.legrandoc.com