

Mosaic™
Controls 20 AX

Cat. No(s): 0 770 60L/63L/92L

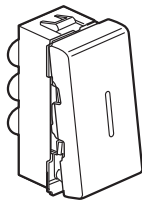

0 770 60L

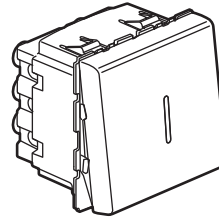

0 770 63L

1. USE

General lighting control mechanisms with or without signalling components (indicator light).
 The mechanisms can be flush-mounted or surface-mounted.
 To be equipped with plate.

2. RANGE

Description	Cat. No
TWO POLE SWITCH - 2 modules To be equipped with an indicator Cat. No 0 676 64 for indicator or illuminated function	0 770 63L
TWO WAY SWITCH - 1 module To be equipped with an indicator Cat. No 0 676 64 for indicator function	0 770 60L
TWO WAY SWITCH 20 AX - 2 modules To be equipped with an indicator Cat. No 0 676 64 for indicator or illuminated function	0 770 92L

3. DIMENSIONS (mm)

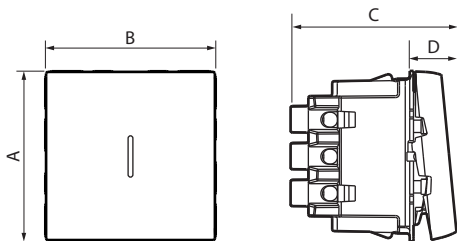

Cat. No	A	B	C	D
0 770 60L	45	22.5	30	12.5
0 770 63L	45	45	31.5	12.5
0 770 92L	45	45	31.5	12.5

4. CONNECTION

Type of terminals: with screws
 Terminal capacity: 2 x 4 mm²
 Stripping length: 10 mm
 Screwdriver: Flat 4 mm - Posidrive n° 1 - Philips n° 1

5. WIRING

■ **5.1 Illuminated function** : illuminates the switch in the dark.
0 770 60L/92L

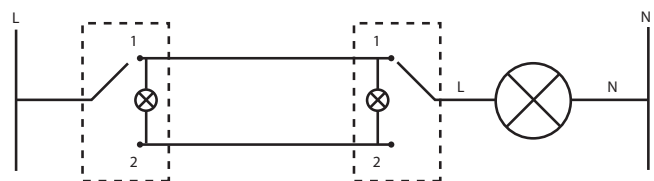

0 770 63L

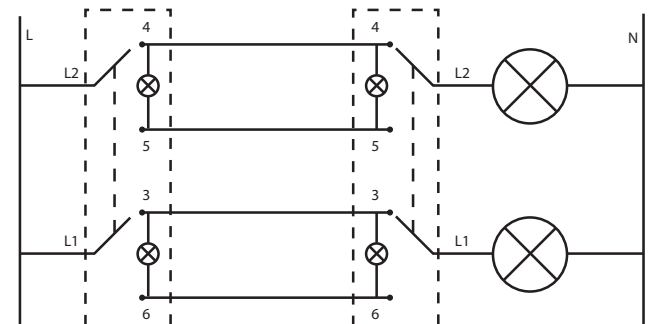
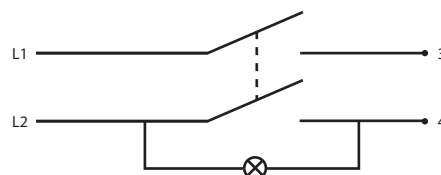

5. WIRING (continued)

■ 5.2 Indicator function:

0 770 60L/92L

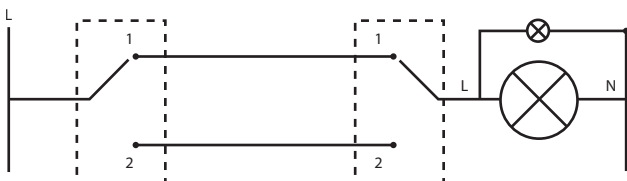

0 770 63L

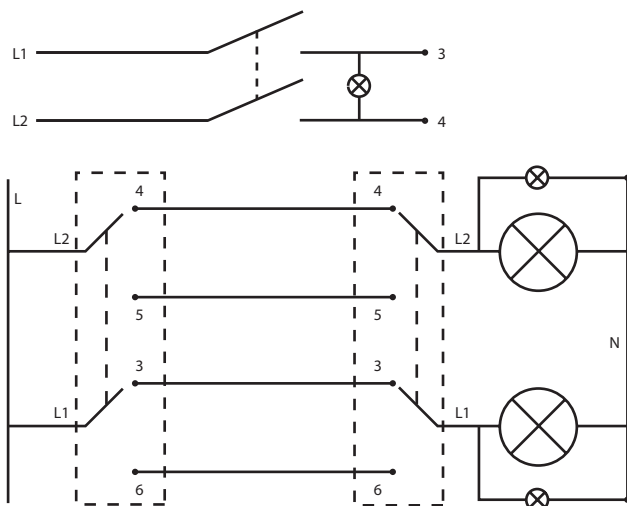

6. TECHNICAL CHARACTERISTICS

■ 6.1 Mechanical characteristics

Impact tests: IK 04

Protection against solid bodies and liquids: IP 31 D

Nota: Switching mechanism (handling force 2 to 3 N).

■ 6.2 Material characteristics

Rocker: White RAL 9003 ABS + PC white opalescent

Base: PC

Rocker support: PC

Halogen-free

UV-resistant

Self-extinguishing:

850°C/30 s for insulating components holding live parts in place.

650°C/30 s for other insulating components.

■ 6.3 Electrical characteristics

Voltage: 250 VAC

Current: 20 AX

Max. power for self-ballasted lamps: 250 W

■ 6.4 Climate characteristics

Storage temperature: - 10°C to + 70°C

Usage temperature: - 5°C to + 35°C

7. CLEANING

Surface cleaning with a cloth.

Do not use: acetone, tar remover, trichloroethylene.

■ 7.1 Resistance to cleaning products

Hexane (EN 60669-1), methylated spirits, soapy water, diluted ammonia, pure bleach diluted to 10%, window-cleaning products, pre-impregnated wipes.

■ 7.2 Resistance to hospital-type cleaning agents

Anios, Surfanios, Bactylisine, Diluted hydrogen peroxide (35%).

Caution: Always test before using other special cleaning products.

8. ACCESSORIES

Lights for switches with indicator light:

Cat. No 0 676 64 (230 V - 2.4 mA)

Cat. No 6 650 90 (230 V - 0.15 mA)

Cat. No 6 650 91 (230 V - 3.0 mA)

9. STANDARDS AND APPROVALS

Compliant with installation and manufacturing standards.

See e.catalogue.