

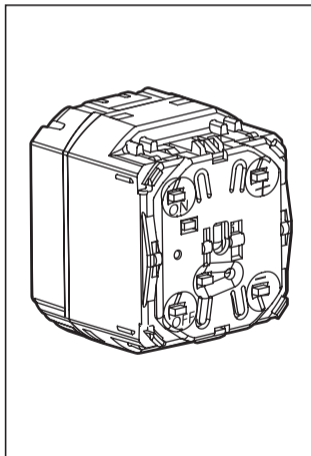









Céliane™

Variateur toutes charges incandescentes télécommandable

670 87

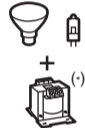
 **legrand**®



 35° 0° 100-240 Vac 50-60Hz	 1 x 2,5 mm ² 2 x 1,5 mm ²					
						
240 Vac	Max.	400 W	400 W	400 VA	400 VA	
	Min.	40 W	40 W	40 VA	40 VA	
100 Vac	Max.	200 W	200 W	200 VA	200 VA	
	Min.	20 W	20 W	20 VA	20 VA	

(-) Seuls les transformateurs prévus pour une utilisation avec un interrupteur électronique doivent être utilisés

LE00789AB

Touche
de configuration

Récepteur
Infrarouge

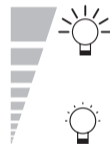
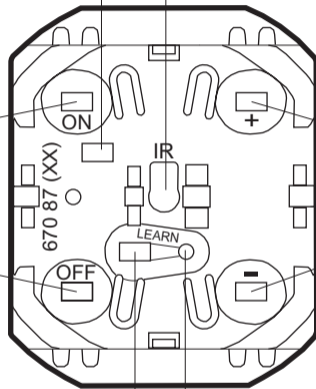

Touche
d'apprentissage

Voyant
d'apprentissage

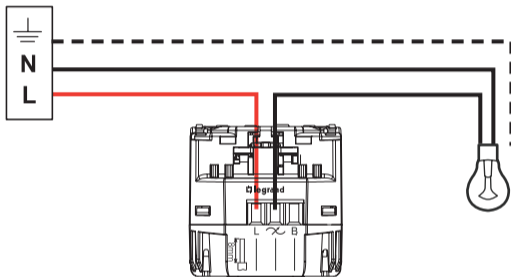

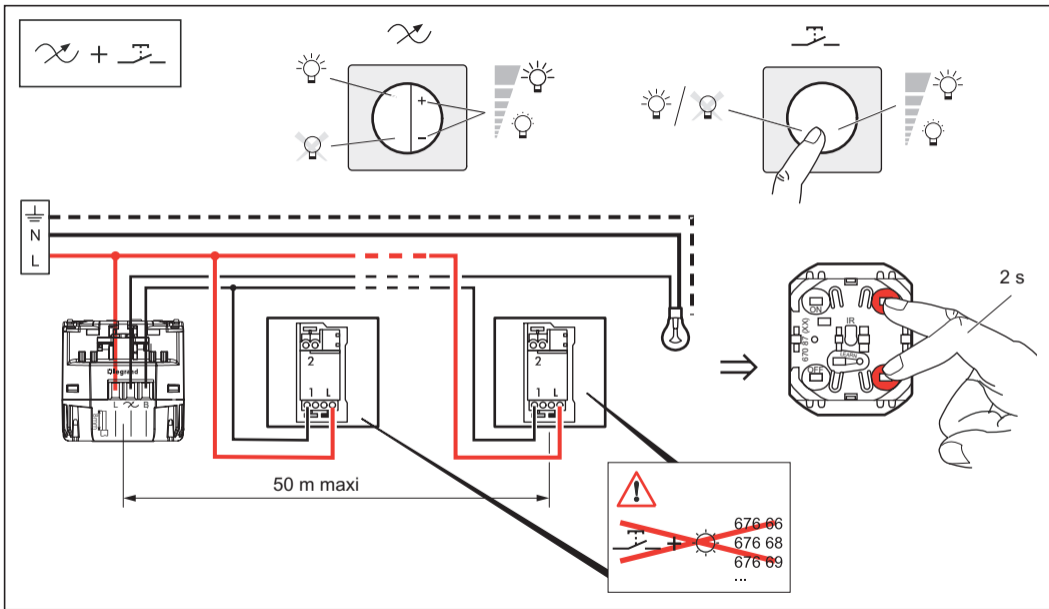

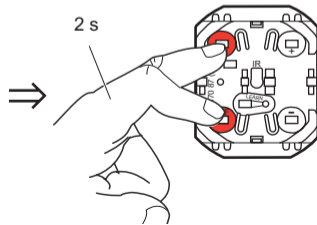
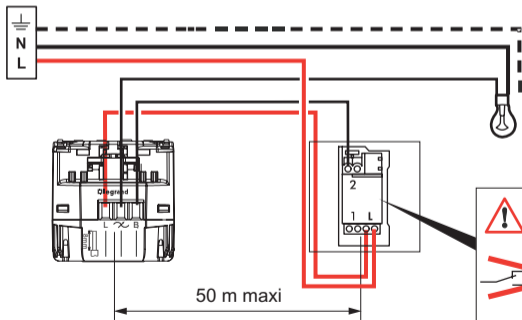
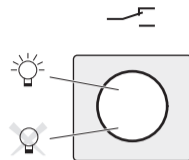
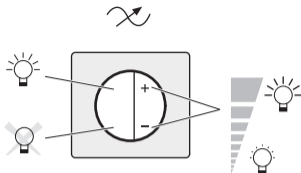
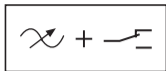



Mode variateur (préréglé en usine)

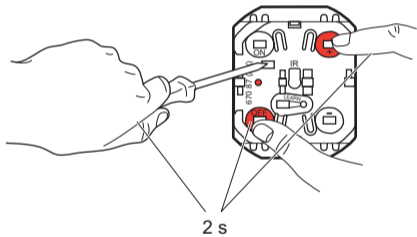
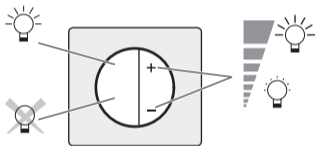



Mode niveaux prééglés + veilleuse

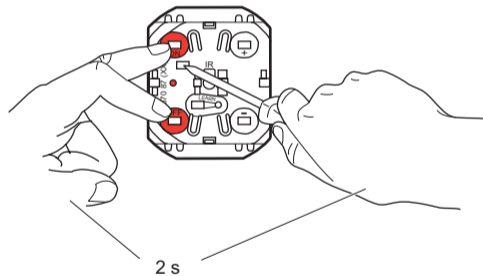
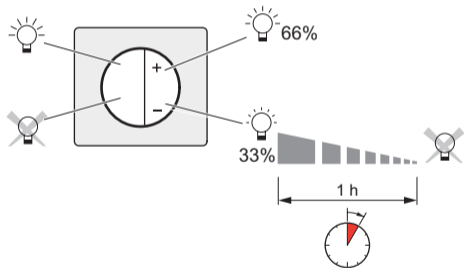



Mode niveaux prééglés

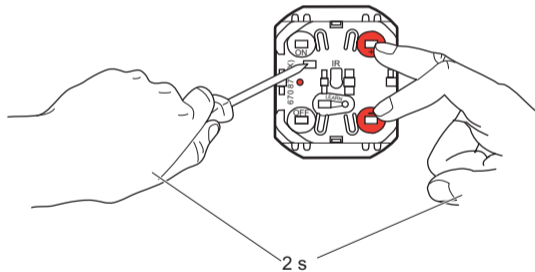
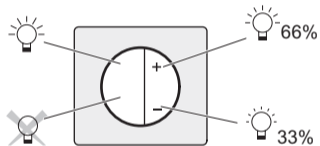



Activation mémoire de niveau (préréglé en usine)

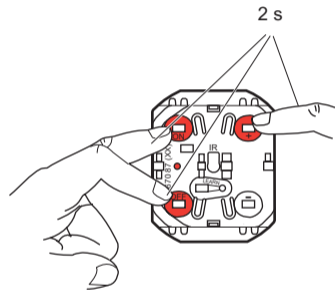
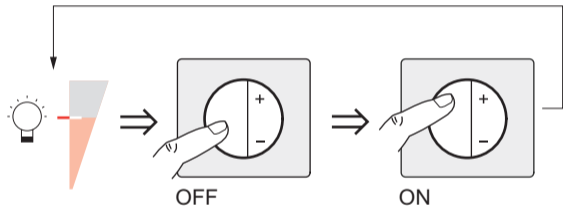



Désactivation mémoire de niveau

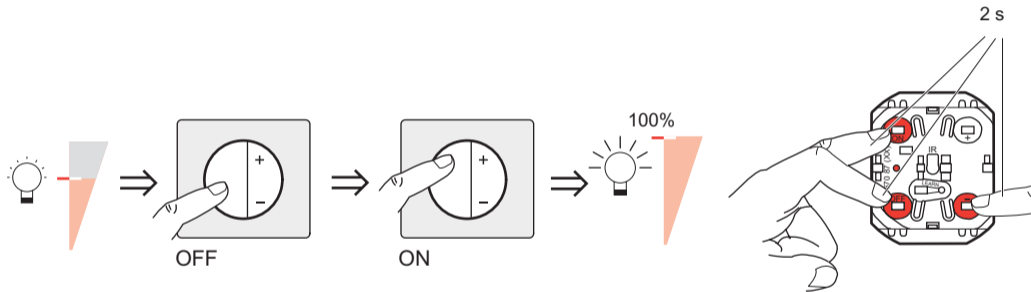

Programmation du variateur pour être associée à une télécommande IR.

Les touches ON, OFF, + et - peuvent être associées à 4 touches d'une télécommande IR

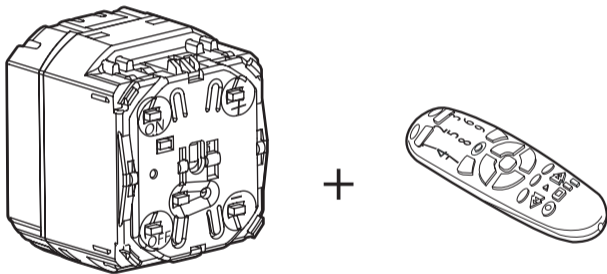

La procédure qui suit est à répéter pour chaque touche de la télécommande à associer

1

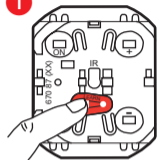

Appui bref

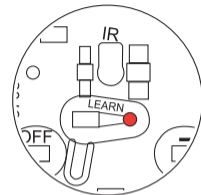

Le voyant s'allume

2

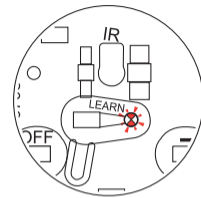
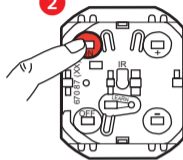

Le voyant clignote lentement(*)

3

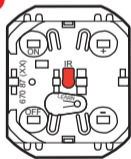

1^{er} appui bref

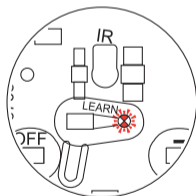
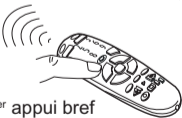

Le voyant clignote rapidement

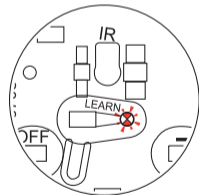

Le voyant clignote lentement

(*) Si le voyant Learn est éteint la touche est déjà programmée

4

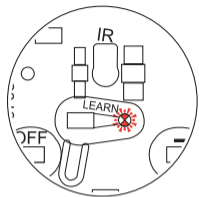
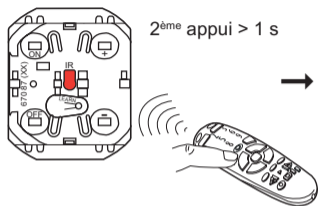

Le voyant clignote rapidement (5 s)(*)

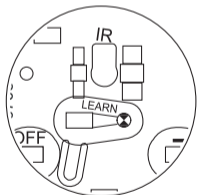

Le voyant s'éteint

2 s

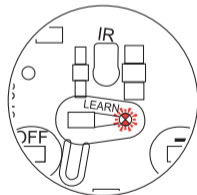

La programmation est terminée

(*)Si un voyant rouge clignote la touche de la télécommande n'est pas compatible

Pour effacer une touche de la télécommande

1

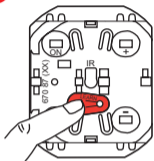

1^{er} appui bref

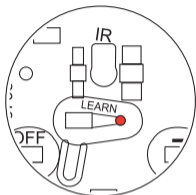

Le voyant s'allume

2

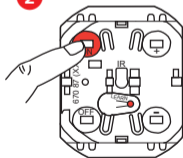

2^{ème} appui long 10 s

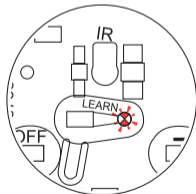

Le voyant flashe 5 s

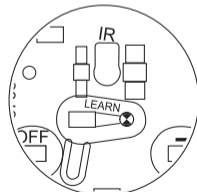

Le voyant s'éteint

Pour effacer tous les codes enregistrés

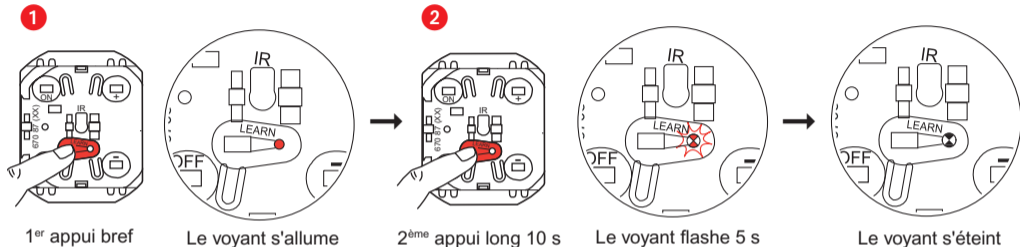

⦿ Le voyant s'éteint



Le voyant clignote lentement



Le voyant clignote rapidement



Le voyant flashe



Consignes de sécurité

FR LU BE

Ce produit doit être installé conformément aux règles d'installation et de préférence par un électricien qualifié. Une installation et une utilisation incorrectes peuvent entraîner des risques de choc électrique ou d'incendie. Avant d'effectuer l'installation, lire la notice, tenir compte du lieu de montage spécifique au produit.

Ne pas ouvrir, démonter, altérer ou modifier l'appareil sauf mention particulière indiquée dans la notice. Tous les produits Legrand doivent exclusivement être ouverts et réparés par du personnel formé et habilité par Legrand. Toute ouverture ou réparation non autorisée annule l'intégralité des responsabilités, droits à remplacement et garanties.

Utiliser exclusivement les accessoires de la marque Legrand.