

**Arteor™**  
**LCS2 Cat. 6A UTP RJ 45 socket**

Cat. No(s): 5 723 49/58/59 - 5 728 49/58/59 - 5 723 57 - 5 728 57

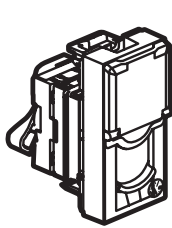

5 723 49

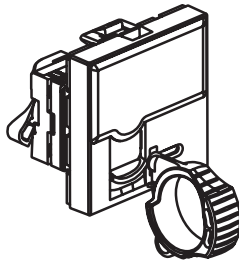

5 723 57

**CONTENTS**

**Page**

1. General characteristics ..... 1  
2. Presentation ..... 1  
3. Real life scenarios ..... 1  
4. Technical characteristics ..... 2  
5. Connection ..... 2  
6. Overall dimensions ..... 2  
7. Usual connection of RJ 45 sockets ... 2  
8. Standards and approvals ..... 3  
9. Performance ..... 3-5

**1. GENERAL CHARACTERISTICS**

Cat. 6A RJ 45 terminal socket for high speed connection to a network.  
Enables data transmission at 10 Gbit/s.  
Socket is used with Cat. 6A U/UTP cables.

**2. PRESENTATION**

	Désignation	Nbre de modules	UTP
	RJ 45 socket Cat. 6A UTP white	1	5 723 49
	RJ 45 socket Cat. 6A UTP magnesium	1	5 728 49
	RJ 45 socket Cat. 6A UTP white orange cover	1	5 723 58
	RJ 45 socket Cat. 6A UTP white green cover	1	5 723 59
	RJ 45 socket Cat. 6A UTP magnesium orange cover	1	5 728 58
	RJ 45 socket Cat. 6A UTP magnesium green cover	1	5 728 59
	RJ 45 socket safety Cat. 6A UTP white	2	5 723 57
	RJ 45 socket safety Cat. 6A UTP magnesium	2	5 728 57

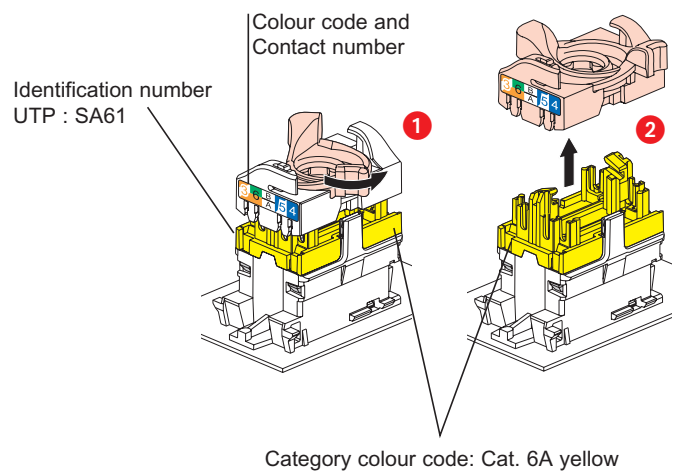

**3. REAL LIFE SCENARIOS**

Mechanisms can be flush-mounted or surface-mounted.

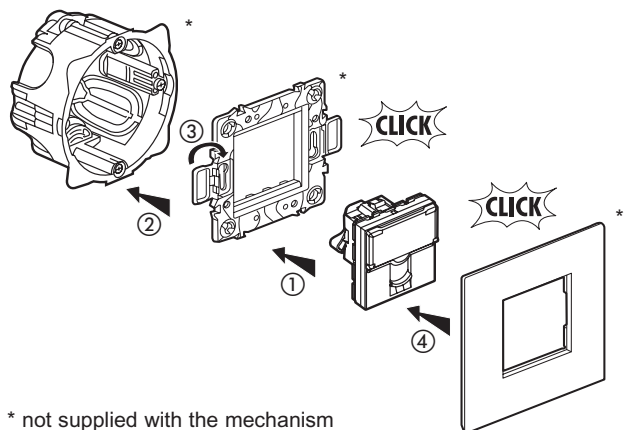

Unlocking

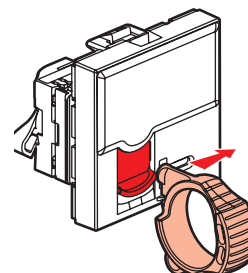

4. TECHNICAL CHARACTERISTICS

4.1 Material characteristics

Contacts: gold/nickel, minimum thickness of gold > 0.8 µm  
 Metal parts: bronze, nickel, platinum, gold  
 PBT polycarbonate

4.2 Electrical characteristics

Breakdown voltage ≥ 1000 V  
 Contact resistance ≤ 20 mΩ  
 Insulation resistance ≥ 500 MΩ at 100 V DC  
 Connector tested and guaranteed under PoE restrictions, IEEE 802.3af standard and PoE+, draft standard 802.3at, up to 2500 on-load connections / disconnections.

Tests are carried out with 2 simultaneous PoE+ circuits for a minimum total power of 50 W.

4.3 Mechanical characteristics

Max. number of connections and disconnections: 5 without refreshing the wiring.  
 Endurance: 2500 movements (plug insertion/withdrawal) IK03

4.4 Climatic characteristics

Operating temperature: - 40° C to + 70° C  
 Humid heat cycle 21 days

5. CONNECTION

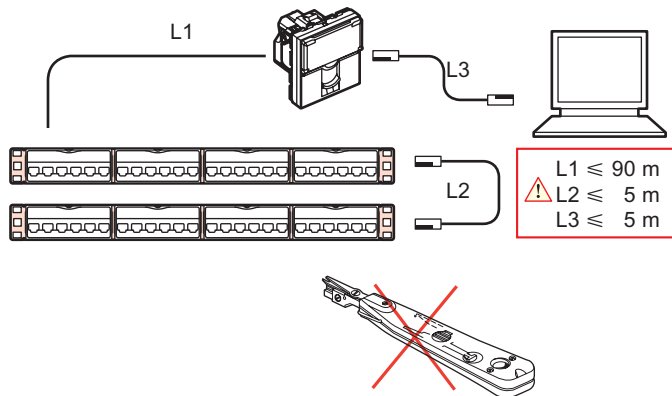

6. OVERALL DIMENSIONS

Front view:

5 723 57 - 5 728 57

5 723 49/58/59 - 5 728 49/58/59

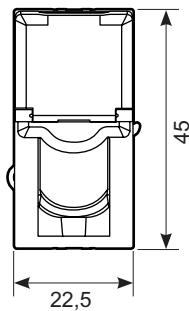
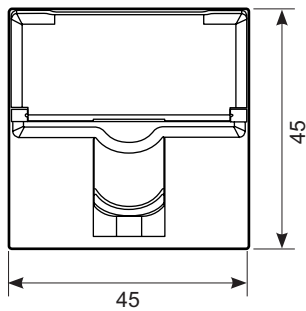

6. OVERALL DIMENSIONS (cont.)

Side view:

5 723 49/58/59 - 5 728 49/58/59  
 5 723 57 - 5 728 57

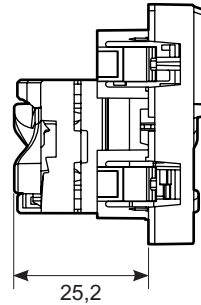

7. USUAL CONNECTION OF RJ 45

Accepts the following cable connectors:  
 RJ11 (4 contacts), RJ12 (6 contacts), RJ45 (9 contacts).  
 Double colour code EIA – TIA 568 A and B on terminals:

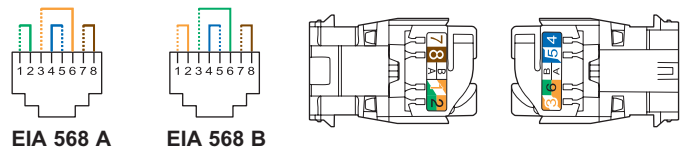

Conductors supported:

- Single-wire: 0.5 to 0.65 mm, AWG 22 to 25
- Multiple-wire: AWG 26
- Polyethylene conductor insulation: max Ø with insulation 1.58 mm.

RJ 45 connectors are equipped with a locking nut that does not require the use of a specific tool and which enables re-cabling in the event of error.

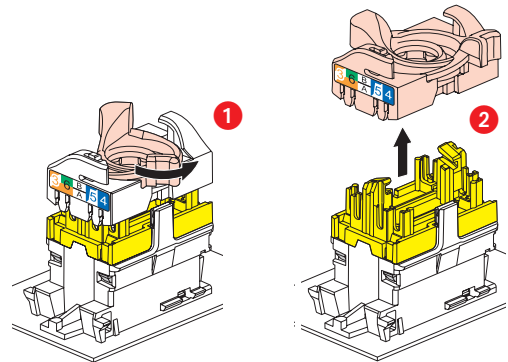

**7. USUAL CONNECTION OF RJ 45 (cont.)**

This system allows the wire pairs to be spread easily before mounting them on the connector.

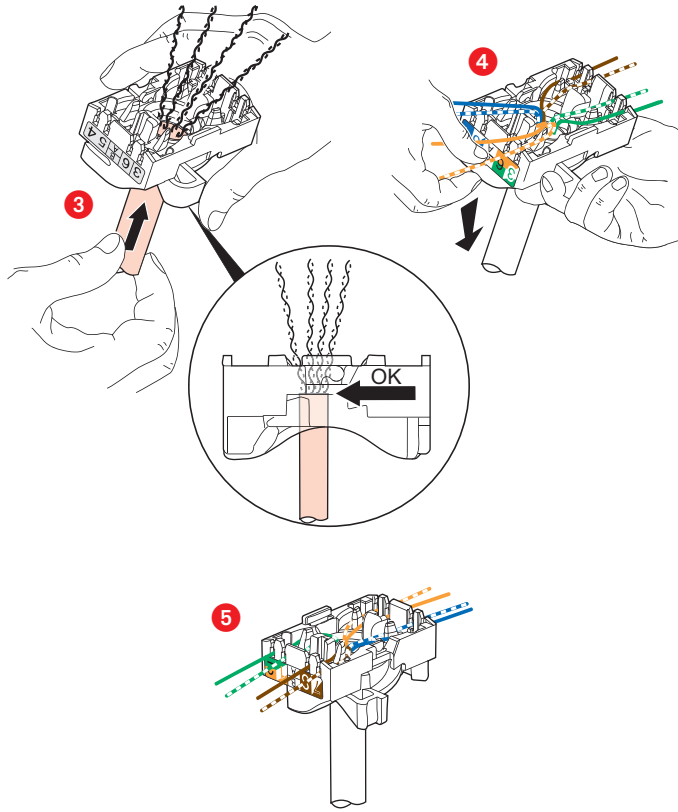

Spreading cables ensures that each pair is separated by the specified 13 mm.  
 Spreading pairs by 90° in relation to the cable ensures optimum performance.

**8. STANDARDS AND APPROVALS**

Compliant with standards: ISO 11801 Second edition  
 EN 50173 Second edition  
 EIA/TIA-568-B.2  
 NF C 20730  
 Standard 8877 - 603.7

**9. PERFORMANCE**

**9.1 Performance of permanent link with cat. 6A U/UTP cable**  
 Return loss

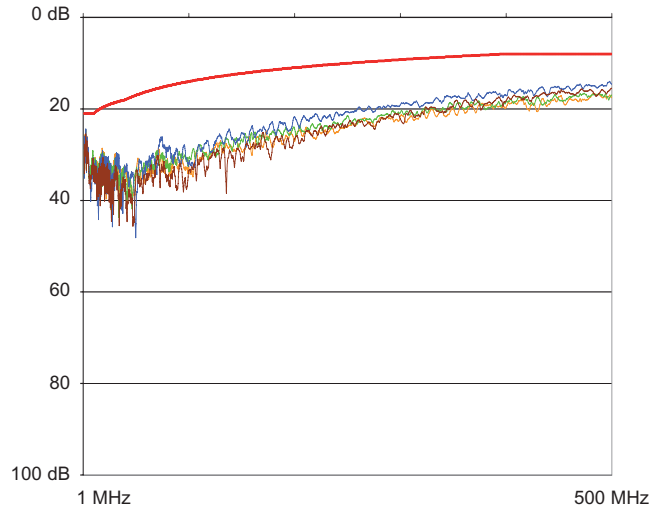

**Attenuation**

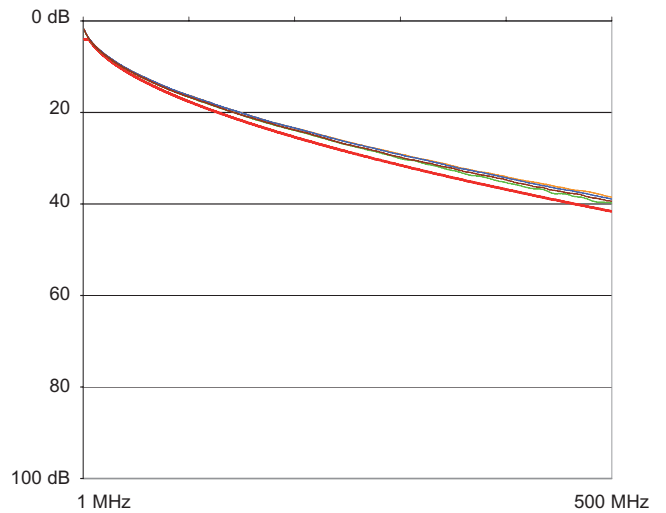

**NEXT (Near end Crosstalk Attenuation)**

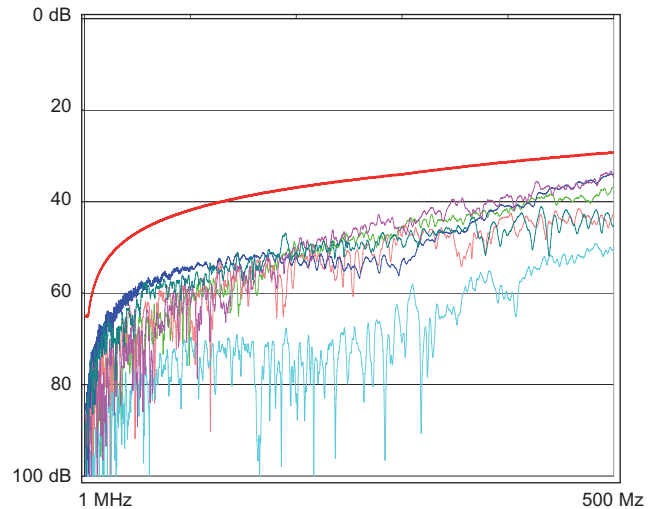

**9. PERFORMANCE (cont.)**

**9.1 Performance of permanent link with Cat. 6A U/UTP cable (cont.)**  
 PS NEXT (Power Sum NEXT)

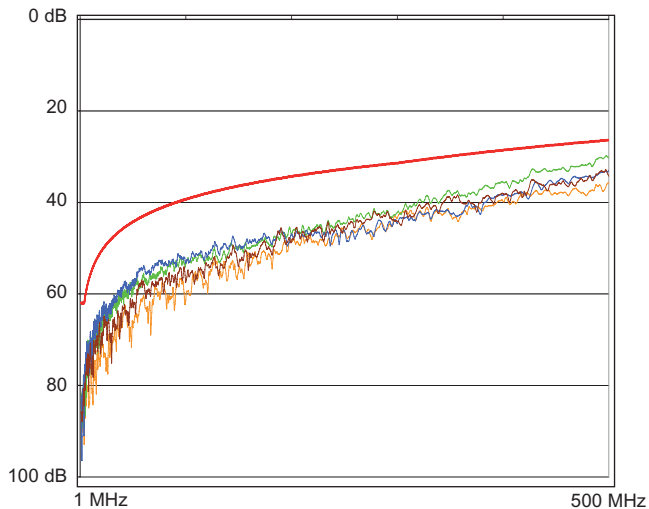

**9.2 Performances canal (Channel)**

Return loss

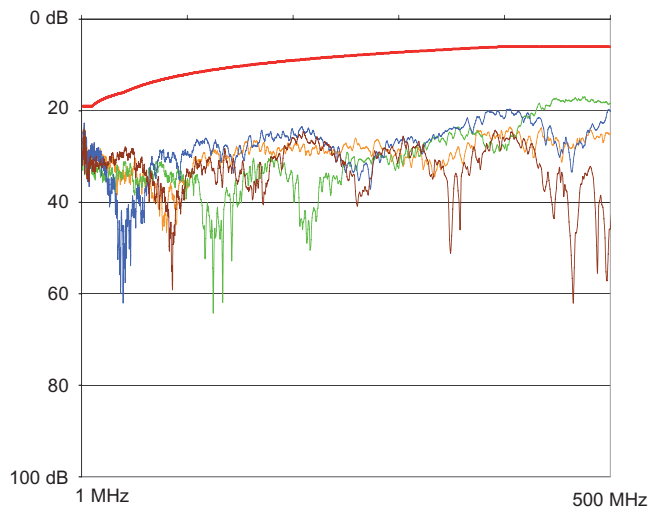

ACR-N (Attenuation to Crosstalk Ratio)

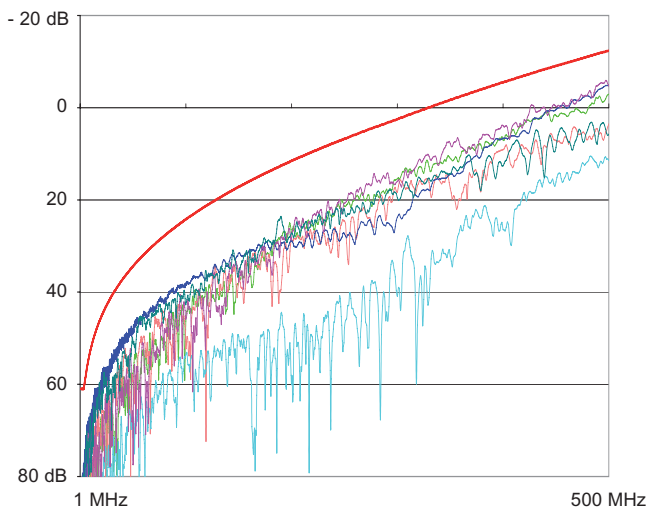

Attenuation

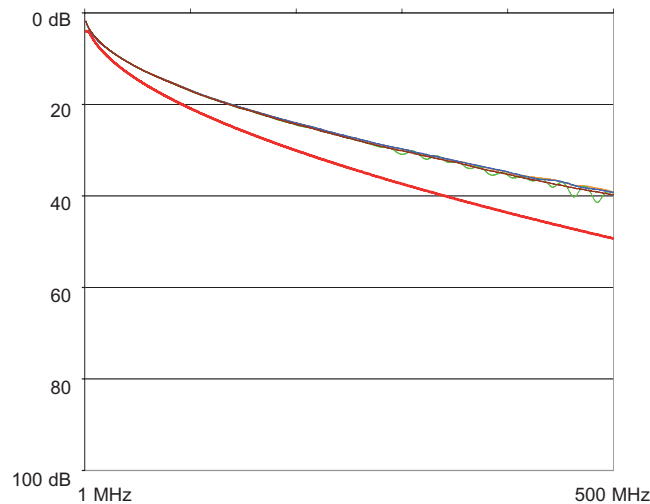

ACR-F (Equal Level End Crosstalk Attenuation)

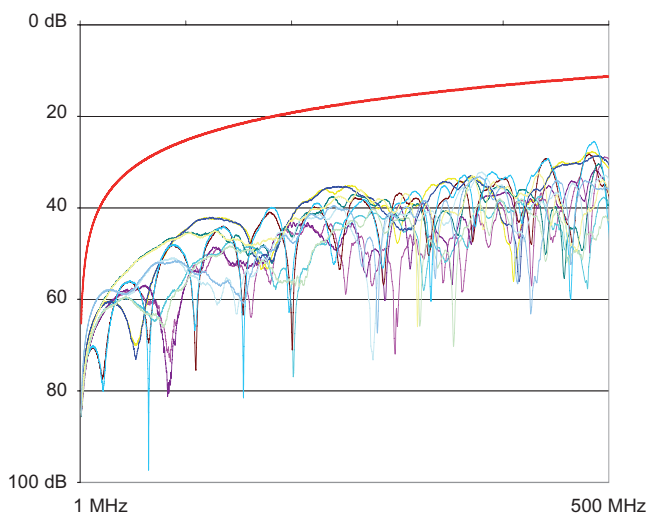

NEXT (Near end Crosstalk Attenuation)

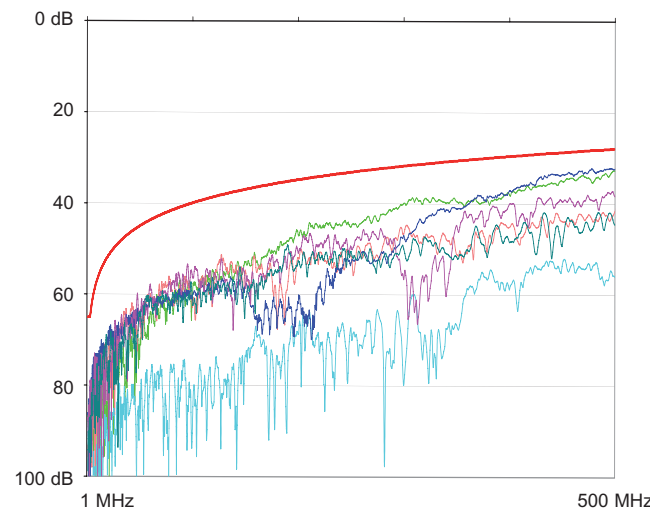

9. PERFORMANCE (cont.)

9.2 Performances canal (Channel) (cont.)

PS NEXT (Power Sum NEXT)

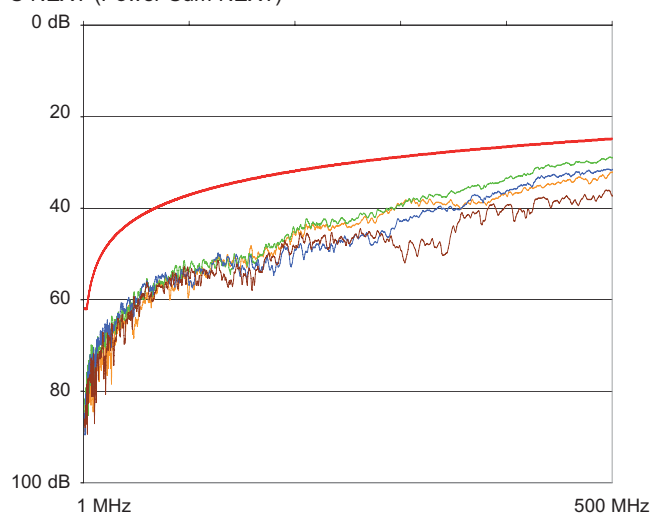

ACR-N (Attenuation to Crosstalk Ratio)

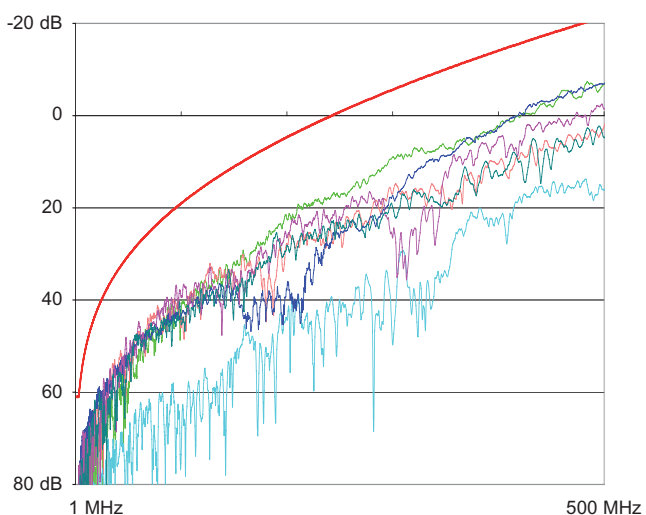

ACR-F (Equal Level End Crosstalk Attenuation)

